





SECTION 2 BALUSTRADE & POOL



Wholesale Price List OCT 2023

www.opushardware.com

SECTION 2 | BALUSTRADE AND POOL

Product	Page
Channel Systems	4 - 23
- SMART LOCK Channel 	6 - 9
- LUGANO Channel	10 - 13
- ANZIO Channel	14 - 17
- CLEARVISTA Channel	18 - 19
- MONACO Clamp Channel (Light Commercial)	20 - 21
Stand-off Disc Systems	22 - 35
- SD50 Discs	24 - 27
- SD75 Discs	28 - 29
- SD100 Discs	30 - 31
- PF150 Discs	32 - 33
- PRADIS Clamp	34 - 35
Semi-Frameless Posts	36 - 37
Vortex Modular Post System 	38 - 39
Mini Posts & Spigots	40 - 51
- SSP15/10 Oval Base Fixed Strut Posts	43
- SP13 Face/Side Fixed Strut Posts 	44
- SP14 Centrally Fixed Strut Posts 	45
- PR160 Round Base Fix Spigot	46
- PS175 Square Base Fix Spigot	47
- MOOD Railing LED Spigot Light System 	48
Consumables, Adhesives and Grout	51
Gate Hinges, Latches & Pivots	52 - 59
Handrail Systems & Clamps	60 - 67
Opus Hardware Service Offering - (Freight + Powdercoating)	68 - 69

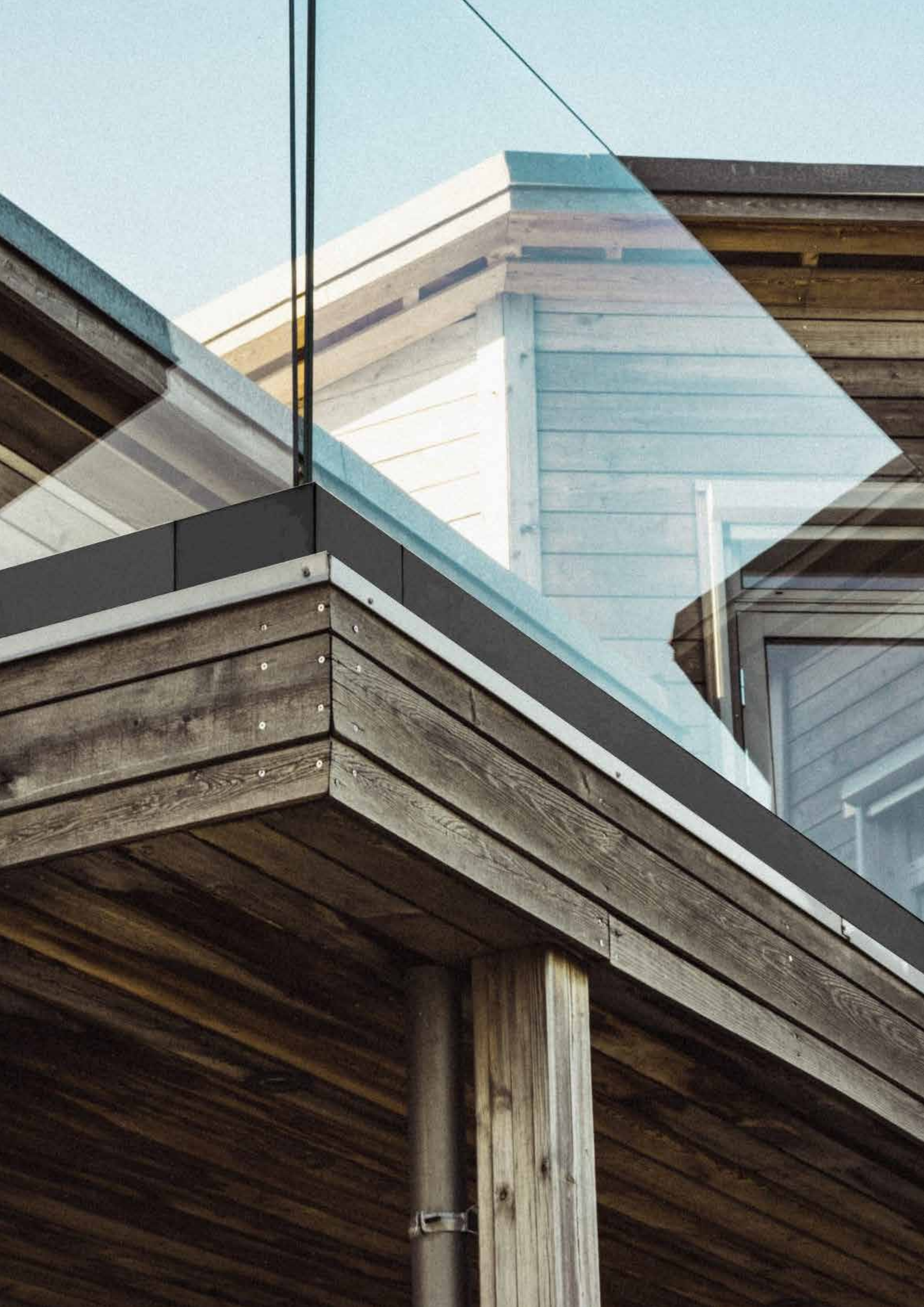

PRODUCT OVERVIEW | CHANNEL SYSTEMS



BALUSTRADE & POOL CHANNEL SYSTEMS

SYSTEM	MAX WIND LOAD (Subject to glass type & fixing method)	OCCUPANCY TYPE/S	GLASS CAPACITIES	SUITABLE SUBSTRATE
SMART LOCK (Top & Side Fix)	Extra High	A, B, E, C1/C2, C3, D & C5	12mm to 25mm	Concrete, Timber, Steel
LUGANO (Side Fix)	Extra High	A & C3	12mm to 13.5mm	Concrete, Timber, Steel
ANZIO (Top Fix)	Extra High	A, B, E, C1/C2, C3 & D	12mm - 17.5mm	Concrete, Timber, Steel
CLEARVISTA (Side Fix)	Extra High	A, B, E & C3	12mm - 17.5mm	Concrete, Timber, Steel
MONACO (Side Fix)	Extra High	A, B, E, C1/C2, C3 & D	15mm to 21.5mm	Concrete, Timber, Steel

PRODUCT OVERVIEW | CHANNEL SYSTEMS



SMART LOCK | Top/Side Fixed Channel

The Smart Lock System was developed for cantilevered structural balustrades to cope with the transition from monolithic Toughened Safety Glass (TSG) to Toughened Laminated Safety Glass (TLSG). The unique design uses a special high strength hollow-core aluminium extrusion and special (single side adjustment) glass clamp kits that secure and locate the glass into the aluminium section.

PAGES: 6 - 9



LUGANO | Residential Side Fixed Channel

The Lugano Balustrade Channel is our aluminium system for face-fixing balustrades reflecting the latest trend for clean flush surfaces, continuous sightlines and square edges. The fixings of Lugano Balustrade are concealed beneath a slim profile aluminium cover plate which can be colour powder-coated to blend with the building structure.

PAGES: 10 - 13



ANZIO | Top Fixed Channel

The Anzio Balustrade System is the latest innovation on frameless glass barrier design which is a floor mounted cantilevered frameless glass barrier system. No need for scaffolding, the Anzio system is easily installed from the deck without the need for ladders or scaffolding. Quick to install and easy to adjust. ned to date. Architecturally designed with square edges, the square shaped profile allows for flooring to be easily butted up against Anzio for a tidy seamless look.

PAGES: 14 - 17



CLEARVISTA | Side Fixed Channel

The Vista Channel is an ideal system for Deck Balustrades. Providing a slim, minimalistic look while delivering unobscured views, superior strength, durability and paramount safety. The Vista System has been crafted using high strength extruded aluminium and can be finished in a powder coat colour of your choice.

PAGES: 18 - 19



MONACO | Commercial Side Fixed Clamp

Monaco Balustrade is very similar to our Lugano system; Monaco Balustrade is designed to take higher loads than LUGANO and is the best system to use for swimming pool fences with large glass spans (heights) or windbreaks that require thicker glass.

PAGES: 20 - 21



TOP/SIDE FIXED CHANNEL SMART LOCK





SMART LOCK 3.0 METRE KITS

PRODUCT & DESCRIPTION	FINISH	GLASS SIZE	CODE	3.0M PRICE	
SL120B Base Fix System Complete with cladding cover, gaskets and glass clamps. (3.0 metre kit)	Satin Stainless Brushed	12mm	SL120B12		
		15mm	SL120B15		
		19mm	SL120B19		
		13.5mm	SL120B13		
		17.5mm	SL120B17		
		21.5mm	SL120B21		
	Black (Brushed ANO)	12mm	SL120BM12		
		15mm	SL120BM15		
		19mm	SL120BM19		
		13.5mm	SL120BM13		
		17.5mm	SL120BM17		
		21.5mm	SL120BM21		
		Satin Stainless Brushed	12mm	SL120S12	
			15mm	SL120S15	
19mm	SL120S19				
13.5mm	SL120S13				
17.5mm	SL120S17				
21.5mm	SL120S21				
Black (Brushed ANO)	12mm	SL120SM12			
	15mm	SL120SM15			
	19mm	SL120SM19			
	13.5mm	SL120SM13			
	17.5mm	SL120SM17			
	21.5mm	SL120SM21			

- * Powdercoat or Anodising P.O.A.
- * Additional Fixing Kits on page 9.
- * No Glass Cutouts Required.
- * Pricing is in 3 metre kits





SMART LOCK COMPONENTS

PRODUCT	DESCRIPTION	FINISH	CODE	3.0M PRICE
	Base Channel Only (Drilled) 3.0mtr	MILL	SLBC	
	Side Channel Only (Drilled) 3.0mtr	MILL	SLSC	
	Side Cladding Only	Satin Stainless Brushed	SLSCSS	
		Black (Brushed ANO)	SLSCBK	
	Top Seal Strip Only *Doesn't include bulb seal, please refer to Bulb Seal Gasket section for respective glass thicknesses.	Satin Stainless Brushed	SLTS-SS	
		Black (Brushed ANO)	SLTS-BK	
	Bottom Cladding Only	Satin Stainless Brushed	SLBC-SS	
		Black (Brushed ANO)	SLBC-BK	





*Powdercoat or Anodising P.O.A

(*Pricing per length)

PRODUCT	DESCRIPTION	GLASS SIZE	CODE	PRICE
	Glass Clamp Kits Only *Each kit contains 10 clamps *The clamps can fit glass thicknesses 1mm either way of nominal glass thickness i.e. 15mm glass clamps will suit 14-16mm glass.	to suit 12mm glass	SLC12	
		to suit 15mm glass	SLC15	
		to suit 19mm glass	SLC19	
		to suit 13.5mm glass	SLC13	
		to suit 17.5mm glass	SLC17	
		to suit 21.5mm glass	SLC21	

PRODUCT	DESCRIPTION	SIZE	FINISH	CODE	PRICE	
	End Caps *price per cap	Base Fix	suit SL120B	Satin	SLECB-SS	
		Face Fix	suit SL120S	Satin	SLECS-SS	
		Base Fix	suit SL120B	Black	SLECB-BK	
		Face Fix	suit SL120S	Black	SLECS-BK	

SMART LOCK COMPONENTS & FIXING KITS

PRODUCT	DESCRIPTION	SIZE	CODE	PRICE
	Quick Lock Ratchet Spanner For fittment and adjustment		SLSPN	
	Joining Pin *price per pin	N/A	SLCD	
	Bulb Seal *price per metre	Suits 12-17mm Glass	SLBS-12	
		Suits 19-21mm Glass	SLBS-19	
		Suits 25mm Glass	SLBS-25	
	Between Glass Rubber		SLCG	

PRODUCT	DESCRIPTION	CODE	PRICE	
	Fixing Kits Base/Top Fix	Concrete	SLCFIX1	
		Steel	SLSFIX1	
		Timber (Through Bolt)	SLTBFIX1	
		Timber (Lag Screw)	SLLSFIX1	
	Side/Face Fix	Concrete	SLCFIX2	
		Steel	SLSFIX2	
		Timber (Through Bolt)	SLTBFIX2	
		Timber (Lag Screw)	SLLSFIX2	

*EPDM Washers not included in Kits. Fixing Kits sold per mounting hole set.

*Additional Adhesives, Sealants may be required,

*Fixing kits include stainless fixtures only.

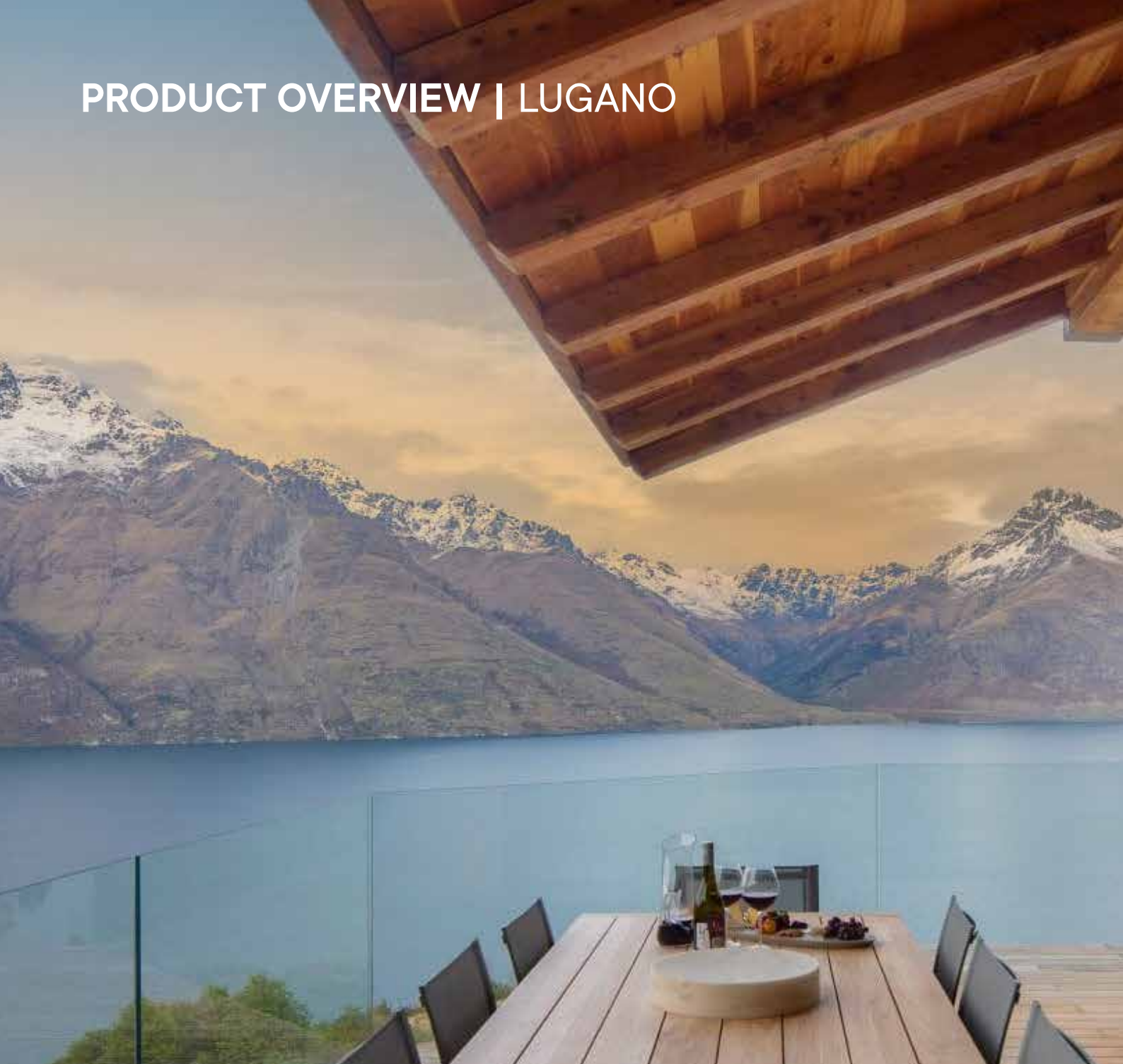

RESIDENTIAL SIDE FIX CHANNEL
LUGANO

LUGANO KITS (12-13.5MM GLASS)

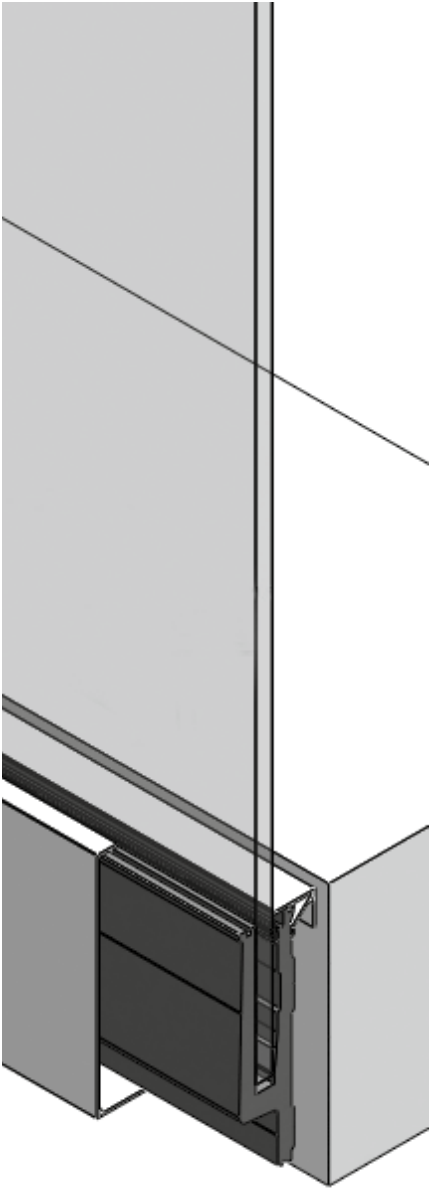
PRODUCT	DESCRIPTION	LENGTH	FINISH	GLASS SIZE	CODE	PRICE
	Concrete Fix Kit	4.8m	MILL	12mm	EFCC48-M	
				13.5mm	EFCC48C-M	
		Silver Pearl	12mm	EFCC48-SP		
			13.5mm	EFCC48C-SP		
		2.4m	MILL	12mm	EFCC24-M	
				13.5mm	EFCC24C-M	
	Silver Pearl	12mm	EFCC24-SP			
		13.5mm	EFCC24C-SP			
	Steel Fix Kit	4.8m	MILL	12mm	EFCS48-M	
				13.5mm	EFCS48C-M	
		Silver Pearl	12mm	EFCS48-SP		
			13.5mm	EFCS48C-SP		
2.4m		MILL	12mm	EFCS24-M		
			13.5mm	EFCS24C-M		
Silver Pearl	12mm	EFCS24-SP				
	13.5mm	EFCS24C-SP				
Timber Fix Kit (Through Bolt)	4.8m	MILL	12mm	EFCT48-M		
			13.5mm	EFCT48C-M		
	Silver Pearl	12mm	EFCT48-SP			
		13.5mm	EFCT48C-SP			
	2.4m	MILL	12mm	EFCT24-M		
			13.5mm	EFCT24C-M		
Silver Pearl	12mm	EFCT24-SP				
	13.5mm	EFCT24C-SP				
Timber Fix Kit (Lag Screw)	4.8m	MILL	12mm	EFCL48-M		
			13.5mm	EFCL48C-M		
	Silver Pearl	12mm	EFCL48-SP			
		13.5mm	EFCL48C-SP			
	2.4m	MILL	12mm	EFCL24-M		
			13.5mm	EFCL24C-M		
Silver Pearl	12mm	EFCL24-SP				
	13.5mm	EFCL24C-SP				



* Kits come complete with Channel, Front & Back covers, Wedge Rubber, Glazing Fillet, Setting Blocks & specified Fixing Kits.

* Fixing Kits do not include EPDM washers.

* Powdercoat or Anodising P.O.A.

* No Glass Cutouts Required.

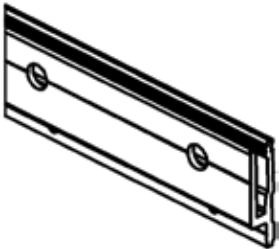
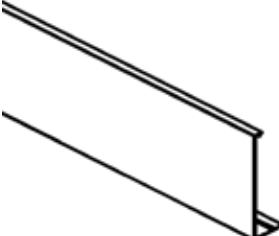
LUGANO COMPONENTS



PRODUCT	DESCRIPTION	FINISH	CODE	PRICE
	Channel Only 4.8m (Drilled)	MILL	EFC48	
	Front Cover Only 4.8m	MILL	EFCFC48M	
		Silver Pearl	EFCFC48SP	
	Back Cover Only 4.8m	MILL	EFCBC48M	
		Silver Pearl	EFCBC48SP	

*Powdercoat or Anodising P.O.A

PRODUCT	DESCRIPTION	FINISH	CODE	PRICE
	End Cap	MILL	EFCEND-M	
		Silver Pearl	EFCEND-SP	
	Internal Corner Cover	MILL	EFCINT-M	
		Silver Pearl	EFCINT-SP	
	External Corner Cover	MILL	EFCEXT-M	
		Silver Pearl	EFCEXT-SP	

*Powdercoat or Anodising P.O.A

LUGANO COMPONENTS & FIXINGS

PRODUCT	DESCRIPTION	CODE	PRICE
	Flat Washer (With EPDM Seal)	FWEPDM	
	Glass Setting Blocks (12 x 6 x 100mm)	EFCSB	
	Clear Film (5mtr Roll)	EFC-TAPE	
	Red Rigid Glazing Fillet 12mm (1mtr)	EFCGF-12	
	Black Rigid Glazing Fillet 13mm (1mtr)	EFCGF-13	
	Rigid Glazing Fillet Tool (Right)	EFCGF-TR	
	Rigid Glazing Fillet Tool (Left)	EFCGF-TL	
	Installation Tools (Spanners, & Hex Handle)	EFC-TOOLS	

PRODUCT	DESCRIPTION	TYPE	CODE	PRICE
	Fixing Kits	Concrete	EFCFIX	
		Steel	EFCSEFIX	
		Timber (Through Bolt)	EFCFTFIX	
		Timber (Lag Screw)	EFCCLFIX	

*EPDM Washers not included in Kits. Fixing Kits sold as Top & Bottom set.



TOP FIXED CHANNEL
ANZIO

ANZIO SYSTEM KITS (12-17.5MM GLASS)

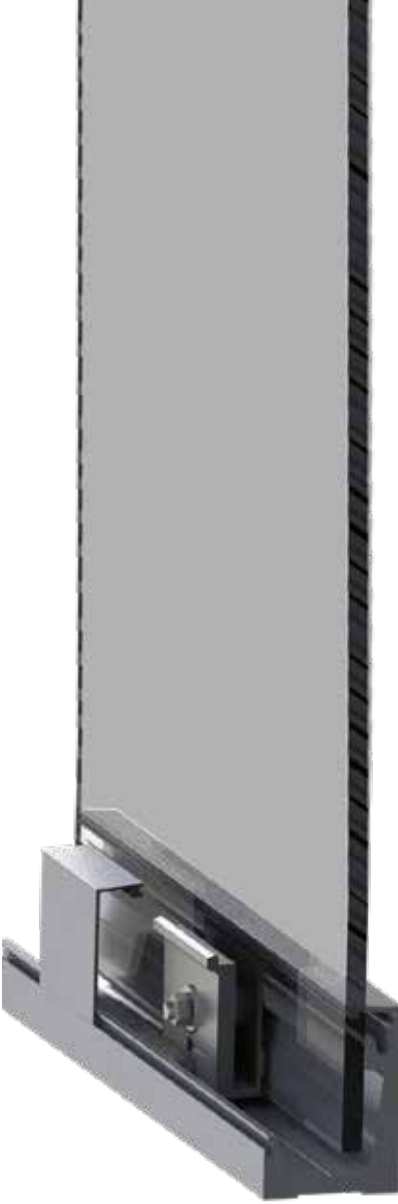
PRODUCT	DESCRIPTION	LENGTH	FINISH	CODE	PRICE
	Concrete Fix Kit	5.0m	MILL	ETBC5A-M	
			Silver Pearl	ETBC5A-SP	
		2.5m	MILL	ETBC25A-M	
			Silver Pearl	ETBC25A-SP	
	Timber Fix Kit	5.0m	MILL	ETBL5A-M	
			Silver Pearl	ETBL5A-SP	
		2.5m	MILL	ETBL25A-M	
			Silver Pearl	ETBL25A-SP	
	Steel Fix Kit	5.0m	MILL	ETBS5A-M	
			Silver Pearl	ETBS5A-SP	
		2.5m	MILL	ETBS25A-M	
			Silver Pearl	ETBS25A-SP	

* Specify Glass thickness on order (12, 13.5, 15, 17.5mm).

* Kits come complete with base, cover plate, clamping kits, gaskets, seals & specified Fixing Kits.

* Extra fixing sets are required for C1, C2 & D occupancies - SD = Specific Design.



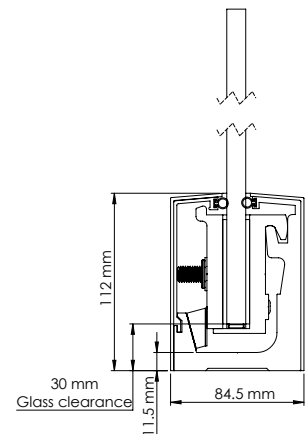
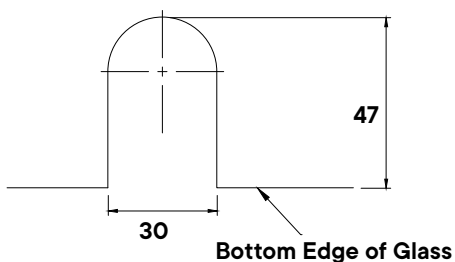

* Powdercoat or Anodising P.O.A.



ANZIO SYSTEM COMPONENTS

PRODUCT	DESCRIPTION	FINISH	CODE	PRICE
	Base Only 5.0m (Drilled)	MILL	ETBBASE5M	
		Silver Pearl	ETBBASE5SP	
	Front Cover Only 5.0m	MILL	ETBCOVER5M	
		Silver Pearl	ETBCOVER5SP	

*Powdercoat or Anodising P.O.A

PRODUCT	DESCRIPTION	CODE	PRICE	
	End Cap Each	MILL	ETBENDM	
		Silver Pearl	ETBENDSP	
	Clamping Kit Set Gaskets sold separately, see below.		ETBKIT	
			ETBG12	
	Gaskets Each - For ETBKIT		ETBG135	
			ETBG15	
			ETBTAPE (5m roll)	
			ETBSP	
	O Seal For Cover Plate & Base Channel		ETBGR	
			EDCGR	
	Concrete Fixing Set		ETBCFIX	
	Timber Fixing Set		ETBLFIX	
	Steel Fixing Set		ETBSFIX	





SIDE FIX CHANNEL CLEARVISTA

CLEARVISTA (OBFC) KITS (12-17.5MM GLASS)

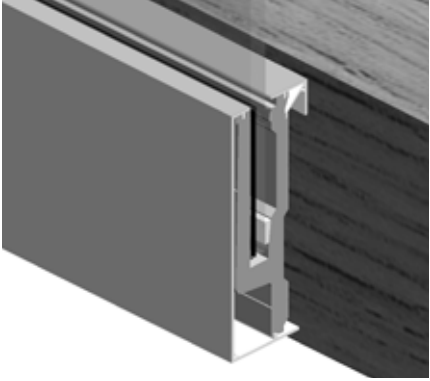



PRODUCT	DESCRIPTION	LENGTH	CODE	PRICE
	ClearVista (OBFC) System Kits (Mill Finish)	Full length 4.8m	OBFC-48M	
		Per mtr	OBFC	

*Kits come complete with Channel, Front & Back covers, Clamping plate, Grub screws & Plastic packers.

*Suits 12-17.5mm Glass (May require Specific Design)

*Powdercoat or Anodising P.O.A

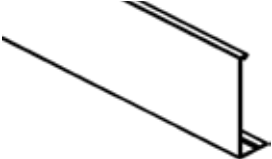
*No Glass Cutouts Required

PRODUCT	DESCRIPTION	LENGTH	CODE	PRICE
	Channel Only (Drilled)	4.8m	OBFCB48	
		2.4m	OBFCB24	
	Inner Clamp Only	4.8m	OBFCFC48	
		2.4m	OBFCFC24	
	Front Cover Only (Mill)	5m	OBFCFC48	
		2.5m	OBFCFC24	
	Back Cover Only (Mill)	5.2m	OBFCBC48	
		2.6m	OBFCBC24	
	End Cap		OBFCEC	

PRODUCT	DESCRIPTION	TYPE	CODE	PRICE
	Fixing Kits	Concrete	OFIX7	
		Steel	OFIX	
		Timber (Through Bolt)	OFIX6	
		Timber (Lag Screw)	OFIX8	



COMMERCIAL SIDE FIX CLAMP
MONACO

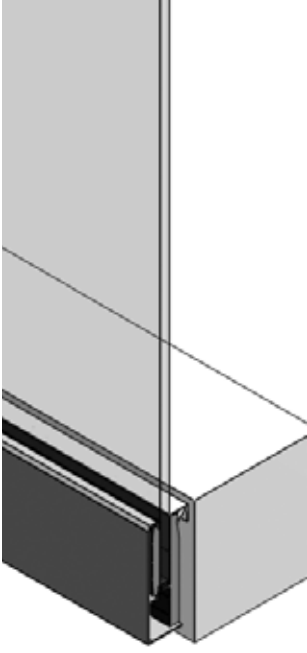

MONACO SYSTEM KITS (15-21.5MM GLASS)

PRODUCT	DESCRIPTION	LENGTH	FINISH	CODE	PRICE
	Timber Fix Kit	4.8m	MILL	EGLT48M	
			Silver Pearl	EGLT48SP	
		2.4m	MILL	EGLT24M	
			Silver Pearl	EGLT24SP	
	Concrete Fix Kit	4.8m	MILL	EGLC48M	
			Silver Pearl	EGLC48SP	
2.4m		MILL	EGLC24M		
		Silver Pearl	EGLC24SP		
Steel Fix Kit	4.8m	MILL	EGLS48M		
		Silver Pearl	EGLS48SP		
	2.4m	MILL	EGLS24M		
		Silver Pearl	EGLS24SP		

- * Kits come complete with glass support, continuous clamp, front & back cover plates.
- * Suits 15mm to 21.5mm glass & includes specified fixings.
- * Fixing kits do not include EPDM washers.
- * Powdercoat or Anodising P.O.A.
- * Commercial applications can vary in price depending on occupancy.

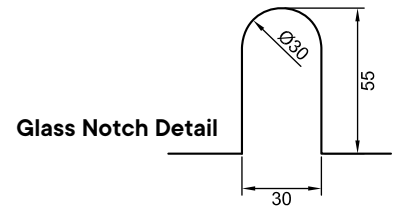
*Pricing per length

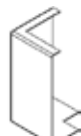

PRODUCT	DESCRIPTION	FINISH	CODE	PRICE
	End Cap 15mm Glass	RIGHT HAND	MILL Silver Pearl	EGLEC15RM EGLEC15RSP
		LEFT HAND	MILL Silver Pearl	EGLEC15LM EGLEC15LSP
	End Cap 17mm Glass	RIGHT HAND	MILL Silver Pearl	EGLEC17RM EGLEC17RSP
		LEFT HAND	MILL Silver Pearl	EGLEC17LM EGLEC17LSP
	Internal Corner Cover	MILL	EFCINTM	
		Silver Pearl	EFCINTSP	
	External Corner Cover	MILL	EFCEXTM	
		Silver Pearl	EFCEXTSP	

PRODUCT OVERVIEW | STANDOFF FITTINGS



BALUSTRADE & POOL STANDOFF FITTINGS

SYSTEM	MAX WIND LOAD (Subject to glass type & fixing method)	OCCUPANCY TYPE/S	GLASS CAPACITIES	SUITABLE SUBSTRATE
SD50 (50mm Double Disc System)	Extra High	A, B, E & C3	12mm - 17.5mm	Concrete, Timber, Steel
SD75 (75mm Single Disc System)	Extra High	A, B, E & C3	12mm - 17.5mm	Concrete, Steel
SD100 (100mm Single Disc System)	Very High	A, B, E & C3	12mm - 17.5mm	Concrete, Steel
PF150 (Point Fix Plate System)	Very High	A, B, E & C3	12mm - 17.5mm	Concrete, Timber, Steel
PRADIS (Standoff Pradis Clamp System)	Extra High	A, B, E, C1/C2, C3, C5, D & F	12mm to 21.5mm	Concrete, Timber, Steel

PRODUCT OVERVIEW | STANDOFF FITTINGS



SD50 | 50mm DoubleDisc System

The DoubleDisc SD50 system is a 50mm diameter traditional stainless steel anchor fixing offering, ideal for those seeking a more industrial frameless glass balustrade aesthetic. The standoff body sets the glass panels out from the deck to assist with water draining and cleaning. The system is ideal for external/internal balconies, stairs and landings. It can be fixed directly to either timber, steel or concrete surfaces and is finished with an interlinking top rail (where required) in a choice of stainless steel or powder coat colours to suit. The finish options are mirror polished stainless steel with a hidden fixing detail or satin stainless steel with a visible fixing detail. Adjustable options are also available.

PAGES: 24 - 27



SD75 | 75mm Single Disc System

The SingleDisc SD75 was born from testing and modelling balustrade fixings to determine the optimum economical fitting for clamp fixing balustrades. The outer disc was profiled to give an attractive appearance and the single fixing point means it can be located on the edge of narrow concrete slabs or steel profiles.

PAGES: 28 - 29



SD100 | 100mm Single Disc System

The SingleDisc SD100 was designed to provide a more solid aesthetic look to single point clamping, as an alternative option to DoubleDisc, SD50 or continuous plate systems. The outer and inner discs are simple circular profiles and the single fixing point means it can be located on the edge of narrow concrete slabs or steel profiles.

PAGES: 30 - 31



PF150 | Point Fix Plate System

Designed in response to demands for maximum visibility, the PlateFix PF150 Frameless Glass Balustrade presents minimal fixings and clearer views beyond the glass panels. The PlateFix PF150 is a marine grade stainless steel clamp that fixes 12mm/17.52mm thick toughened glass panels to the external edge of balconies and stairs - as well as for internal stairs and landings. The PlateFix PF150 has a wide body which sets the glass out from the deck 20mm, assisting with water drainage and cleaning, but fixing centres are up to 50% narrower than our traditional DoubleDisc Anchors - providing a comparatively less visual and far more linear fixing detail.

PAGES: 32 - 33



PRADIS | Standoff Pradis Clamp System

Pradis Balustrade showcases the latest in face fixing technology allowing the Pradis clamps to be located up to 800mm from one another for modern simplicity. Pradis is stronger than other conventional systems; anchors, single disc etc. Quick to install and easy to adjust. The Pradis can be fixed to a 150mm tall substrate.

PAGES: 34 - 35

PRODUCT OVERVIEW | SD50 DISCS

50MM BUTTON FITTINGS SD50 DISCS

SD50 DISC ASSEMBLIES

PRODUCT	DESCRIPTION	STANDOFF SIZE	FINISH	CODE	PRICE
	SD50 Screw Head 50mm diameter assembly with stand-off, and flat edge screw head.	30mm	Polished Stainless	SD5030-SH-PS	
			Satin Stainless	SD5030-SH-SS	
		25mm	Polished Stainless	SD5025-SH-PS	
			Satin Stainless	SD5025-SH-SS	
	SD50 Flat Head 50mm diameter assembly with stand-off, and flat edge concealed stepped head.	30mm	Polished Stainless	SD5030-FH-PS	
			Satin Stainless	SD5030-FH-SS	
	SD50 Beveled Head 50mm diameter assembly with stand-off, and beveled flat edge concealed head.	30mm	Polished Stainless	SD5030-BH-PS	
			Satin Stainless	SD5030-BH-SS	
		25mm	Black (PVD)	SD5030-BH-BK	
			Polished Stainless	SD5025-BH-PS	
	SSD50 Square Anchor 50mm Square assembly with stand-off, and flat edge concealed head.	25mm	Polished Stainless	SSD5025-FH-PS	
			Satin Stainless	SSD5025-FH-SS	
	SD50/A Adjustable Anchor 50mm diameter assembly with an adjustable stand-off, and flat edge screw head.	Adjustable (40-50mm)	Polished Stainless	ASD5030-SH-PS	
			Satin Stainless	ASD5030-SH-SS	
	Glass to Cleat Anchor 50mm diameter with round edge head and standoff. Glass to cleat fixing. To suit 10, 12 and 15mm toughened glass.	6mm	Satin Stainless	CA50-SS	
	Square Cover Kit To Convert SD50 Fittings Round Fixings to Square Sets.	30mm	Polished Stainless	SD50SCK-PS	
			Satin Stainless	SD50SCK-SS	



*Fixings ordered separately, see M10 Rod and Lag Screw options (page 29)

*Options for up to 12 - 17.5mm glass.



***SPECIFY GLASS THICKNESS ON ORDER.**

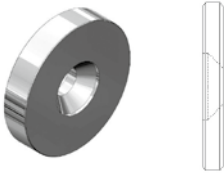
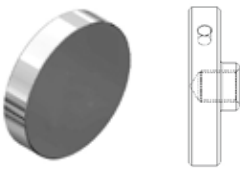
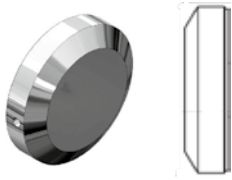
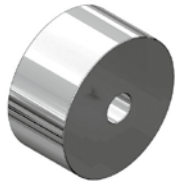





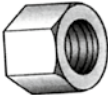

50MM DISC COMPONENTS

PRODUCT	DESCRIPTION	FINISH	CODE	PRICE
	50mm CSK Head Only 50mm Dia x 6mm M10	Polished Stainless	SDSH-PS	
		Satin Stainless	SDSH-SS	
	50mm Flat Stepped Head Only 50mm Dia x 10mm M10	Polished Stainless	SDFH-PS	
		Satin Stainless	SDFH-SS	
	50mm SD50 Button Beveled Head 50mm diameter assembly with 30mm stand-off, and beveled flat edge concealed head.	Polished Stainless	SDBH-PS	
		Satin Stainless	SDBH-SS	
		Black (PVD)	SDBH-BK	
	50mm Threaded Body Only 50mm Dia M10 - SS Finish	BODY WIDTH	CODE	PRICE
		6mm	SDB6-SS	
		20mm	SDB20-SS	
		25mm	SDB25-SS	
		30mm	SDB30-SS	
		40mm	SDB40-SS	
		50mm	SDB50-SS	
		6mm	SDS6-SS	
		20mm	SDS20-SS	
		25mm	SDS25-SS	
30mm	SDS30-SS			
	50mm Spacer Only 50mm Dia 10.5mm Through Hole SS Finish			
	50mm Weatherboard Shim 8 degree angle, 12mm tapered to 5mm, 10.5mm dia. through hole, SS.	12mm > 5mm	SP505WBSS	

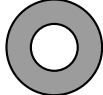
50MM DISC FIXINGS



PRODUCT	DESCRIPTION	M SIZE	LENGTH	CODE	PRICE
	Stainless Steel Rods	M10	50mm	M10-R50	
			100mm	M10-R100	
			115mm	M10-R115	
			140mm	M10-R140	
	SS Lag Screw (External Application)	M10	100mm	LS10100	
			120mm	LS10120	
	Zinc Plated Lag Screw (Internal Application)	M10	70mm	LS100702L	
			100mm	LS101002L	
			120mm	LS101202L	

PRODUCT	DESCRIPTION	SIZE	CODE	PRICE
	Hex Nut	M10	M10-HN	
	Dome Nut	M10	M10-DN	
	Nylon Bush to suit M10 Rod	19.5mm Dia	NB-20	
	Black Fibre Gasket 0.8mm Thick, for Exterior and Interior Applications	50mm Dia	FG-50	
	Opaque LDPE Gasket 0.8mm Thick, for Interior Applications	50mm Dia	LG-50	
	Washers	M10 x 30mm dia washers 2.5mm SS	M10-30	
		50 x 50 x 3 Flat Square Washer SS	M10-SQ	
	Spring Washer	M10 Spring Washer SS	M10-5HR	

PRODUCT OVERVIEW | SD75 DISCS





75MM BUTTON FITTINGS
SD75 DISCS

SD75 DISC ASSEMBLIES

PRODUCT	DESCRIPTION	FINISH	CODE	PRICE
	SD75 Screw Head 75mm diameter assembly with 30mm stand-off, and beveled edge screw head. - Fitting suitable for single line - Fixings at 400mm max centres - Glass hole 25mm	Satin Stainless	SD75	
	Square Cover Kit To Convert SD75 to square fitting. 30mm Standoff	Polished Stainless	SD75SCK-PS	
		Satin Stainless	SD75SCK-SS	

*Fixings ordered separately, see M12 Rod options below
 *Options for up to 12 - 17.5mm glass.

***SPECIFY GLASS THICKNESS ON ORDER.**

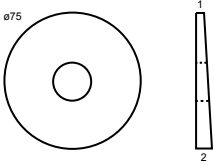
PRODUCT	DESCRIPTION	M SIZE	LENGTH	CODE	PRICE
	Stainless Steel Rods	M12	60mm	M12-R60	
			120mm	M12-R120	
			150mm	M12-R150	
	M12 Hex Nut			M12-HN	
	M12 Dome Nut			M12-DN	
	Black Fibre Gasket 0.8mm Thick, for Exterior and Interior Applications 75mm Dia			FG-75	
	Opaque LDPE Gasket 0.8mm Thick, for Interior Applications 75mm Dia			LG-75	
	Washers	M12 x 24mm dia washers 2.5mm SS		FW1224	
	Tapered shim Black nylon material.		Tapered shim for MB75 fixing. 1-2mm	TS75-1-2	
			Tapered shim for MB75 fixing. 1-3mm	TS75-1-3	





100MM BUTTON FITTINGS SD100 DISCS





SD100 DISC ASSEMBLIES

PRODUCT	DESCRIPTION	FINISH	CODE	PRICE
	<p>SD100 Screw Head</p> <p>100mm diameter assembly with 30mm stand-off, and beveled edge screw head.</p> <p>Compliant to NZS1170 for use in domestic and commercial installations</p> <ul style="list-style-type: none"> - Fitting suitable for single line - Fixings at 400mm max centres - Glass hole 25mm <p>*SD100 is made to order.</p>	Satin Stainless	SD100	

*Fixings ordered separately, see M12 Rod and Lag Screw options below

*Options for up to 12 - 17.5mm glass.

***SPECIFY GLASS THICKNESS ON ORDER.**

PRODUCT	DESCRIPTION	M SIZE	LENGTH	CODE	PRICE
	Stainless Steel Rods	M12	60mm	M12-R60	
			120mm	M12-R120	
			150mm	M12-R150	
	M12 Hex Nut			M12-HN	
	M12 Dome Nut			M12-DN	
	Black Fibre Gasket			FG-100	
	Opaque LDPE Gasket			LG-100	
	Washers	M12 x 24mm dia washers 2.5mm SS		FW1224	





STANDOFF PLATE FIX SYSTEM
PLATEFIX PF150







PF150 PLATEFIX ASSEMBLIES

PRODUCT	DESCRIPTION	CODE	PRICE
	<p>PF150 Plate Fix Fitting.</p> <p>Single or Double point fixing.</p> <p>316SSS Finish.</p> <p>20mm stand off spacer, 6mm outer plate.</p> <p>150mm long with 50mm radius ends.</p> <p>Compliant to AS/NZ1170 for use in both domestic and commercial balustrades and pool fences.</p>	PF150	

*Fixings ordered separately, see M12 Rod and Lag Screw options below

*Options for up to 12 - 17.5mm glass.

***SPECIFY GLASS THICKNESS ON ORDER.**

PRODUCT	DESCRIPTION	CODE	PRICE
	<p>Wood fix M10 x 120mm CSK</p> <p>Socket screw, 50mm diameter Washer & Hex Nut - 316SSS (Double point fix X 2 fixing)</p>	CBW-120	
	<p>Wood fix M12 x 130mm CSK</p> <p>Socket screw, 50mm diameter Washer & Hex Nut - 316SSS (Single point fix X 1 fixing)</p>	CBW-130	
	<p>Hilti 10mm Masonry Sleeve</p> <p>(Double point fix X 2 fixings)</p>	MF110	
	<p>Hilti 12mm Masonry Sleeve</p> <p>(Single point fix X 1 fixing)</p>	MF125	
	<p>Metal Fix</p> <p>10 x 50mm CSK Socket screw, flat washer & Hex Nut 316SSS (Double point fix X 2 fixings)</p>	SF50-10	
	<p>Metal Fix</p> <p>12 x 50mm CSK Socket screw, flat washer & Hex Nut 316SSS (Single point fix X 1 fixing)</p>	SF50-12	



BALUSTRADE STANDOFF CLAMP
PRADIS CLAMP

PRADIS CLAMP

PRODUCT	DESCRIPTION	CODE	PRICE	
	Pradis Face Mounted Clamp			
	PRADIS Anodised Aluminium Clamps can be fixed to the following different substrate types; Concrete, Steel, Timber. Suitable for glass thickness from 12mm to 22.38mm (can be adapted to take other glass thicknesses - upon request)			
	Clamp with Fixing Kit	Satin ANO	EZ1-SA	
		Black	EZ1-BLK	
	Kit for bolt through fixings. M12 x 170mm threaded stud 50 x 50mm square washer, M12 nut.	Satin ANO	EZ1BT-SA	
		Black	EZ1BT-BLK	
	Kit for Steel Substrates M12 x 100mm threaded stud, M12 Nut	Satin ANO	EZ1S-SA	
		Black	EZ1S-BLK	
	Kit for lag screw fixings for exposed Timber substrates. M12 x 200mm lag screw	Satin ANO	EZ1LE-SA	
		Black	EZ1LE-BLK	
	Kit for lag screw fixings for concealed Timber substrates. M12 x 160mm lag screw, EPDM washer	Satin ANO	EZ1LC-SA	
		Black	EZ1LC-BLK	
Kit for Concrete substrates M12 x 170mm threaded stud	Satin ANO	EZ1C-SA		
	Black	EZ1C-BLK		

***SPECIFY GLASS THICKNESS ON ORDER.**

***SPACINGS VARY DEPENDING ON FIXINGS AND SUBSTRATE.**

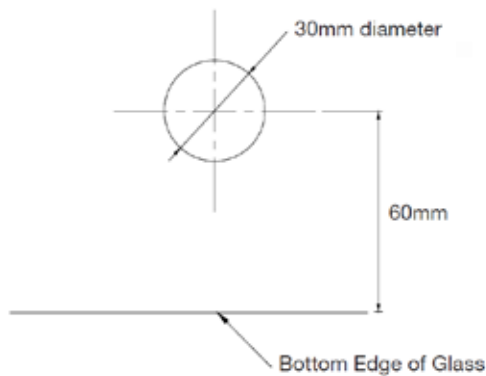



COMMERCIAL BALUSTRADE POSTS SEMI-FRAMELESS POSTS

SEMI-FRAMELESS POSTS

PRODUCT	DESCRIPTION
---------	-------------



Semi-Frameless Balustrade Posts

The Resolute & Milano Balustrade is a frameless full height post system where the top and bottom edges of the glass are exposed. This system can be used as a pool fence, balustrade or as a wind break.

Unlike other systems the posts can be fixed up to 1650mm apart and with 500mm overhangs allows for a panel width of 2650mm overall, which reduces the amount posts required across the deck (Balustrade post locations are based on the wind zone). Based on design loads from AS/ NZS 1170.1 and a max uls wind pressure of 2.13kPa (Extra high wind zone).



Rated for occupancy A, B, E, C1, C2, C3, D and C5. Suited for 8-17.5mm glass.

Fixed at 1650mm centres Max,
Maximum height 2000mm, Maximum glass overhang 500mm (each side).

***Silver Pearl Standard Colour**

***Custom Finishes Available P.O.A**

***Posts are all P.O.A - Please contact the team for further information & pricing.**

PRODUCT	DESCRIPTION	FIXING TYPE	CODE	PRICE
	Floor Mount Includes 1x Post and fixing kit specified.	Concrete	ERPTC	
		Timber/Steel	ERPTS	
	Face Fixed Includes 1x Post and fixing kit specified.	Concrete	ERPFC	
		Bolt Through	ERPFBT	
		Steel	ERPFS	
	Face Fixed *With Concealed Fixings Includes 1x Post and fixing kit specified.	Concrete	ERPHBT	
Steel		ERPHS		

SYSTEM	MAX WIND LOAD <small>(Subject to glass type & fixing method)</small>	OCCUPANCY TYPE/S	GLASS CAPACITIES	MAXIMUM HEIGHTS	SUITABLE SUBSTRATE
RESOLUTE/ MILANO	Extra High	A, B, E, C1, C2, C3, C5, D	8mm - 17.5mm	2000mm above top fixing	Concrete, Timber, Steel

**COMING
SOON!**
2024 RELEASE

MODULAR ALUMINIUM POST SYSTEM
VORTEX RAILING

VORTEX RAILING SYSTEM

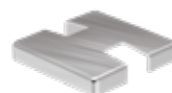
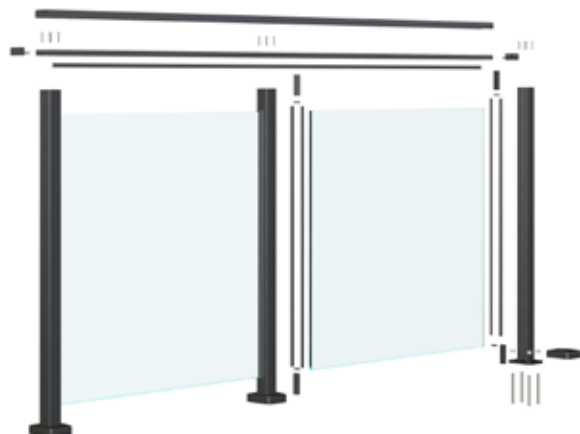

PRODUCT	DESCRIPTION	FIXING TYPE	COLOUR	CODE	PRICE
	VX1 Floor/Top Mount Post Includes 1x Post and fixing kit specified. Supplied in box format at 1100mm, with rubbers, infill, caps. Complete assembly ready for trim if required before simple onsite installation.	Concrete	ANO Silver	VX1C-ANO	
			ANO Black	VX1C-BLK	
		Timber/Steel	ANO Silver	VX1T-ANO	
			ANO Black	VX1T-BLK	
	VX2 Face/Side Mount Post Includes 1x Post and fixing kit specified. Supplied in box format at 1350mm, with rubbers, infill, caps. Complete assembly ready for trim if required before simple onsite installation.	Concrete	ANO Silver	VX2C-ANO	
			ANO Black	VX2C-BLK	
		Timber/Steel	ANO Silver	VX2T-ANO	
			ANO Black	VX2T-BLK	
SYSTEM	MAX WIND LOAD <small>(Subject to glass type & fixing method)</small>	OCCUPANCY TYPE/S	GLASS CAPACITIES	MAXIMUM HEIGHTS	SUITABLE SUBSTRATE
VORTEX	Extra High	A, B, E, C1, C2, C3, C5, D	6mm - 12mm	2000mm above top fixing	Concrete, Timber, Steel

PRODUCT OVERVIEW | SPIGOTS & STRUT POSTS

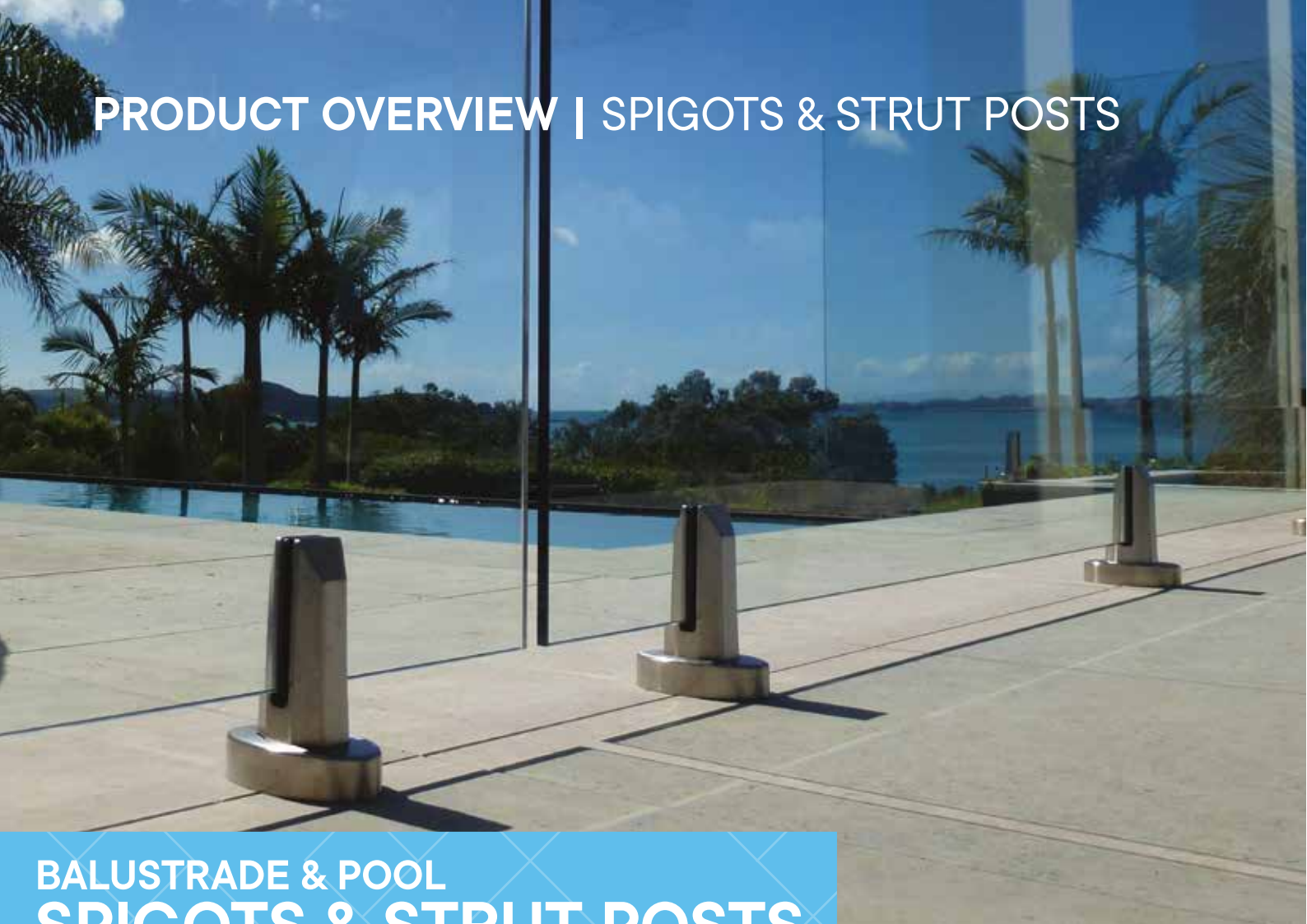

BALUSTRADE & POOL SPIGOTS & STRUT POSTS

SYSTEM	MAX WIND LOAD <small>(Subject to glass type & fixing method)</small>	OCCUPANCY TYPE/S	GLASS CAPACITIES	SUITABLE SUBSTRATE
SP15	Extra High	A, B, E & C3 Pool Fencing	12mm - 17.5mm	Concrete, Timber, Steel
SP10	Medium - High	A, B, E & C3 Pool Fencing	10mm - 13.5mm	Concrete, Timber, Steel
SP13	Extra High	A, B, E & C3 Pool Fencing	12mm - 17.5mm	Concrete, Timber, Steel
SP14	Extra High	A, B, E & C3 Pool Fencing	12mm - 17.5mm	Concrete, Timber, Steel
PS175	Medium - High	A & C3 Pool Fencing	10mm to 12mm	Concrete, Timber, Steel
PR160	Medium - High	A & C3 Pool Fencing	10mm to 12mm	Concrete, Timber, Steel

PRODUCT OVERVIEW | SPIGOTS & STRUT POSTS



SP15/10 | Base Fix

The Oval Base fix Strut Posts SP15 & SP10 are a popular choice when it comes to unmatched quality and ease of use. The stunning strut design creates an architectural statement in itself, available in Polished, Satin or Brushed Black. These can be used with 10mm up to 17.52mm Glass.



PAGE: 43



SP13 | Face/Side Fixed

The Face/Side fix Strut Post SP13 is a new product complementing the base fixed posts to allow side fixing applications with larger Glass spans and sizes. These are a popular choice when it comes to unmatched quality and ease of use. The stunning strut design creates an architectural statement in itself, available in Polished, Satin or Black. These can be used with 12mm up to 17.52mm Glass.



NEW!

PAGE: 44



SP14 | Centrally Fixed

The Centrally fixed Strut Post SP14 is a new product complementing the base and side fixed posts to provide a seamless and stunning finished application with all fixings concealed within the core. These are a popular choice when it comes to unmatched quality and ease of use. The stunning strut design creates an architectural statement in itself, available in Polished, Satin or Brushed Black. These can be used with 12mm up to 17.52mm Glass.



NEW!

PAGE: 45



PR160 | Round Base Fix Spigot

Economical Round Spigot base fixed option for pool fences and balustrades. The PR160 Spigot is great option for professionals who want to be able to use an economical spigot for both Pool and Balustrade without the need to compromise with the product tested to perform.

- 10-12mm Glass
- Adjustable base plate
- Compatible with MOOD LED System



PAGE: 46



PS175 | Square Base Fix Spigot

Economical Square Spigot base fixed option for pool fences and balustrades. Like the PR160, The PS175 Spigot is great option for professionals who want to be able to use an economical spigot for both Pool and Balustrade without the need to compromise with the product tested to perform.

- 10-12mm Glass
- Adjustable base plate
- Compatible with MOOD LED System



PAGE: 47







**RUN OUT PRODUCTS
PAGES: 49 - 51**









**BALUSTRADE & POOL
SPIGOTS & STRUT POSTS**

STRUT POSTS

PRODUCT	DESCRIPTION	FINISH	CODE	PRICE
	<p>SP10 Base Fix</p> <p>2 point M10 fixing to substrate 2205 duplex grade</p> <p>For Occupancy A, B, C3, E and pool fences.</p> <p>To be used with 10-13.52mm toughened or toughened laminated glass.</p> <p>No holes or cut outs required in glass.</p>	 <p>Polish</p>	SP10-PS	
		 <p>Brushed Satin</p>	SP10-SS	
		 <p>Black</p>	SP10-BK	
	<p>SP15 Base Fix Heavy Duty Strut Post</p> <p>2 point M12 fixing to substrate 2205 duplex grade</p> <p>For Occupancy A, B, C3, E and pool fences. Up to Very High Wind Zone.</p> <p>Can be used with 12-17.52mm toughened or toughened laminated glass.</p> <p>No holes or cut outs required in glass.</p> <p>Engineered system. Strength exceeds round or square designs.</p>	 <p>Polish</p>	SP15-PS	
		 <p>Brushed Satin</p>	SP15-SS	
		 <p>Black</p>	SP15-BK	
FIXING KITS		METRIC	CODE	PRICE
Masonry Fix	2x 115mm Threaded Rod, Flat Washer and Nut Stainless Steel	M10	SP10FK-1	
		M12	SP15FK-1	
Steel Fix	2x 40mm Hex Bolt, Flat Washer and Nut Stainless Steel	M10	SP10FK-2	
		M12	SP15FK-2	
Timber Fix	2x 180mm Coach Screw & HD Flat Washer Stainless Steel	M10	SP10FK-3	
		M12	SP15FK-3	

STRUT POSTS

PRODUCT	DESCRIPTION	FINISH	CODE	PRICE
	<p>SP13 Face/Side Fix Heavy Duty Strut Post</p> <p>2 point M12 fixing to substrate 2205 duplex grade</p> <p>For Occupancy A, B, C3, E and pool fences. Up to Very High Wind Zone.</p> <p>Can be used with 12-17.52mm toughened or toughened laminated glass.</p> <p>No holes or cut outs required in glass.</p> <p>Engineered system. Strength exceeds round or square designs.</p>	 <p>Polish</p>	SP13-PS	
		 <p>Brushed Satin</p>	SP13-SS	
		 <p>Brushed Black</p>	SP13-BK	

FIXING KITS	CODE	PRICE
<p>Masonry Fix</p> <p>2x 140mm M12 Threaded Rods, Flat Washers and Nuts Stainless Steel</p>	SP13FK-1	
<p>Steel Fix</p> <p>2x 60mm M12 Hex Bolts, 4x Flat Washers and Nuts Stainless Steel</p>	SP13FK-2	
<p>Timber Fix</p> <p>2x 140mm M12 Coach Screws & HD Flat Washers Stainless Steel</p>	SP13FK-3	
<p>Timber Through Fix</p> <p>2x 180mm M12 Threaded Rods, 4x Flat Washers and Nuts Stainless Steel</p>	SP13FK-4	

STRUT POSTS

PRODUCT	DESCRIPTION	FINISH	CODE	PRICE
	<p>SP14 Centrally Fixed Heavy Duty Strut Post</p> <p>Single or Double point M14/M12 fixing to substrate 2205 duplex grade</p> <p>For Occupancy A, B, C3, E and pool fences. Up to Very High Wind Zone.</p> <p>Can be used with 12-17.52mm toughened or toughened laminated glass.</p> <p>No holes or cut outs required in glass.</p> <p>Engineered system. Strength exceeds round or square designs.</p> <p>(Includes center locking nut)</p>	 <p>Polish</p>	SP14-PS	
		 <p>Brushed Satin</p>	SP14-SS	
		 <p>Brushed Black</p>	SP14-BK	

FIXING KITS	CODE	PRICE
<p>Masonry Fix 1</p> <p>1x 180mm M14 Threaded Rod Stainless Steel</p>	SP14FK-1	
<p>Masonry Fix 2</p> <p>2x 120mm M12 Threaded Rods Stainless Steel</p>	SP14FK-2	
<p>Steel Fix</p> <p>2x 60mm M12 Threaded Rods, 2x Flat Washers and Nuts Stainless Steel</p>	SP14FK-3	
<p>Timber Through Fix</p> <p>2x 180mm M12 Threaded Rod, 2x Flat Washers and Nuts Stainless Steel</p>	SP14FK-4	

MINI POST SPIGOTS





PRODUCT	DESCRIPTION	FINISH	CODE	PRICE
	<p>PR160 Round Pool Spigot</p> <p>Domestic and Residential Occupancy A and C3. Rated to be used up to a High wind zone (1.76Kpa or less)</p> <p>To be used with 12mm Glass No Holes in Glass Required Pool & Balustrade</p> <p>Includes Baseplate for adjustment</p>	 <p>Polish</p>	PR160-PS	
		 <p>Satin</p>	PR160-SS	
		 <p>Black</p>	PR160-BK	

FIXING KITS & ACCESSORIES	CODE	PRICE
<p>Masonry M10 Fix</p> <p>4x 140mm M10 Threaded Rods, Flat Washers and Nuts Stainless Steel</p>	PSFKIT-1	
<p>Steel Fix</p> <p>4x 60mm M10 Hex Bolts, 8x Flat Washers and Nuts Stainless Steel</p>	PSFKIT-2	
<p>Timber Fix</p> <p>4x 140mm M10 Coach Screws & HD Flat Washers Stainless Steel</p>	PSFKIT-3	
<p>Timber Through Fix</p> <p>4x 180mm M10 Threaded Rods, 8x Flat Washers and Nuts Stainless Steel</p>	PSFKIT-4	



	<p>MOOD Railing LED Kit</p> <p>Kit of 16x LED assemblies for MOOD Railing Lights, Includes all connectors and remote.</p>	MOODKIT-1	
---	--	-----------	--

MINI POST SPIGOTS

PRODUCT	DESCRIPTION	FINISH	CODE	PRICE
	<p>PS175 Square Pool Spigot</p> <p>Domestic and Residential Occupancy A and C3. Rated to be used up to a High wind zone (1.76Kpa or less)</p> <p>To be used with 12mm Glass No Holes in Glass Required Pool & Balustrade</p> <p>Includes Baseplate for adjustment</p>	 <p>Polish</p>	PS175-PS	
		 <p>Satin</p>	PS175-SS	
		 <p>Black</p>	PS175-BK	

FIXING KITS	CODE	PRICE
<p>Masonry M10 Fix</p> <p>4x 140mm M10 Threaded Rods, Flat Washers and Nuts Stainless Steel</p>	PSFKIT-1	
<p>Steel Fix</p> <p>4x 60mm M10 Hex Bolts, 8x Flat Washers and Nuts Stainless Steel</p>	PSFKIT-2	
<p>Timber Fix</p> <p>4x 140mm M10 Coach Screws & HD Flat Washers Stainless Steel</p>	PSFKIT-3	
<p>Timber Through Fix</p> <p>4x 180mm M10 Threaded Rods, 8x Flat Washers and Nuts Stainless Steel</p>	PSFKIT-4	



	<p>MOOD Railing LED Kit</p> <p>Kit of 16x LED assemblies for MOOD Railing Lights, Includes all connectors and remote.</p>	MOODKIT-1	
---	--	-----------	--

PRODUCT OVERVIEW | MOOD RAILING LED SYSTEM

**NEW!
2024
RELEASE**

LED SPIGOT LIGHTING MOOD RAILING SYSTEM

OVERVIEW







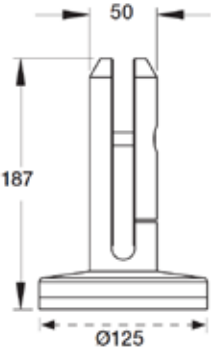

MOOD Railing LED Kit

Kit of 16x LED assemblies for MOOD Railing Lights, Includes all connectors and remote.

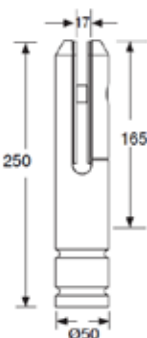
MOODKIT-1

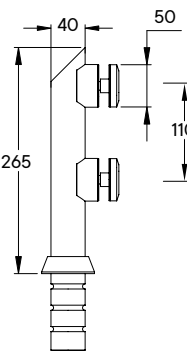
MINI POSTS

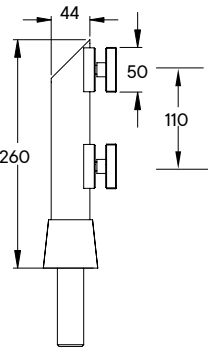
PRODUCT	DESCRIPTION	FINISH	CODE	PRICE
 	<p>FMP350 Mini Post Base Fix</p> <p>Domestic and Residential Occupancy A and C3. Rated to be used up to a very high wind zone (1.76Kpa or less)</p> <p>To be used with 12-13.5mm toughened glass.</p> <p>*Holes Required for Glass mounting</p>	Polish Finish	FMP350PS	
		Satin Finish	FMP350SS	
		Black Finish	FMP350BLK	
 	<p>FMP250 Mini Post Core Drill</p> <p>Domestic and Residential Occupancy A and C3. Rated to be used up to a very high wind zone (1.76Kpa or less)</p> <p>To be used with 12-13.5mm toughened glass.</p> <p>*Holes Required for Glass mounting</p>	Polish Finish	FMP250PS	
		Satin Finish	FMP250SS	
 	<p>EB1 Eurobrace Minipost Spigot</p> <p>Manufactured in 316 grade stainless steel and Suitable for 10, 12 and 15mm glass</p> <p>Posts are set into concrete (Ø50mm hole) and affixed using Sika or Rockite grout.</p>	Polished Stainless	EB1-SS	
		Satin Stainless	EB1-PS	
 	<p>EB2 Eurobrace Minipost Spigot</p> <p>Manufactured in 316 grade stainless steel and Suitable for 10, 12 and 15mm glass</p> <p>Posts are set into concrete (Ø50mm hole) and affixed using Sika or Rockite grout.</p>	Polished Stainless	EB2-SS	
		Satin Stainless	EB2-PS	

GLASS CUT-OUTS SHOWN ON NEXT PAGE

GLASS CUT-OUTS

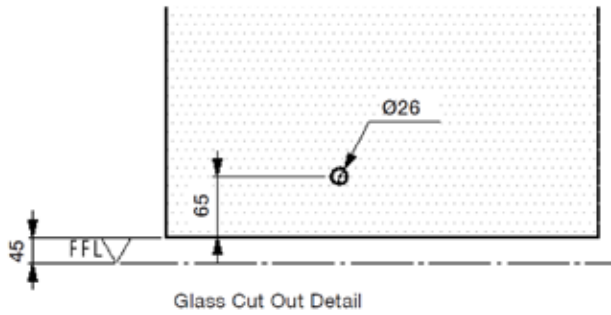

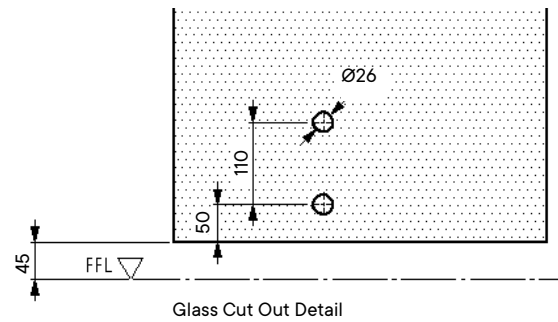

FMP350/FMP250







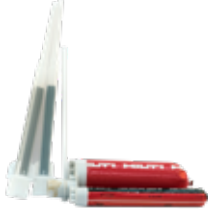

EB1

NAUTECH STRUT POSTS

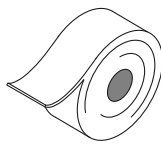
PRODUCT	DESCRIPTION	CODE	PRICE
	<p>Base Fix Strut Post</p> <p>Four point fixing to structure 316 SSS</p> <p>To be used with 12mm glass. No holes or cut outs required in glass</p>	NBF-168	
	<p>Face Fix Strut Post</p> <p>Four point fixing to structure 316 SSS</p> <p>To be used with 12mm glass. No holes or cut outs required in glass</p>	NSF-315	
<p>Masonry Fix M10 x 100mm</p> <p>Threaded rod HD Flat Washer and dome nut</p>		DF-100	
<p>Masonry Anchor Fix</p> <p>Sika-1 - Fits standard cartridge gun</p>		Sika-1	
<p>Metal Fix.</p> <p>M10 x 25mm. Countersunk machine screw. 316SSS</p>		SF-25	
<p>Counter Sunk</p> <p>M10 x 100mm Wood fix coach screw. 316SS</p>		CSW-100	
<p>Wood Fix</p> <p>M10 x 120mm. Countersunk bolt with HD Flat Washer and hex nut 316SS</p>		CBW-120	
<p>Wood Fix</p> <p>M10 x 130 Rod with dome nut face fix and hex nut back fix 316SS</p>		DBW-130	

CONSUMABLES, ADHESIVES AND GROUT



PRODUCT	DESCRIPTION	CODE	PRICE
	HILTI HIT-HY 200 Max Chemical Anchor 330ml Adhesive Cartridge (HY150)	300003	
	SIKA Supergrip Timber 2 Hour Bond 310ml Adhesive Cartridge	300006	
	EPDM / Foam Tape Black, EPDM Barrier (Per Metre)	170 x 1.5mm	302100
		70 x 1.5mm	302101
	Floor Spring Sealing Compound 145/435ml, Protect Floor Spring, Suits component: MFX840 and BTS84	300552	
	SIKA Grout 25kg Bag, Application on Level Floor Spring	300005	
	Link Rail Loctite 243 (300961) Suits S40 Rail, 50mm Bottle Tube Lock Adhesive	TL2650	
	SIKA-1 Masonry Anchor Fix (300ml)		

MFG POOL GATE LATCHES

PRODUCT	DESCRIPTION	GLASS PREPARATION	FINISH	CODE	PRICE
	<p>PGL Gate Latch and Keeper</p> <p>Gate and side panel. Single action, self-latching magnetic operation.</p> <p>Standard for 12mm glass.</p>		Satin Stainless	PGL-SS	
			Polish	PGL-PS	
	<p>PGL-PF Square Post Gate Latch and Strike</p> <p>Gate to post mount. Single action, self-latching magnetic operation.</p> <p>Standard for 12mm glass.</p>		Satin Stainless	PGL-PF-SS	
			Polish	PGL-PF-PS	
	<p>PGL-PR Round Post Gate Latch and Strike</p> <p>Gate 50mm dia. post mount. Single action, self-latching magnetic operation.</p> <p>Standard for 12mm glass.</p>		Satin Stainless	PGL-PR-SS	
			Polish	PGL-PR-PS	
	<p>PGL90 Gate latch and keeper</p> <p>Gate that closes to a side panel at 90°. Single action, self-latching magnetic operation.</p> <p>Standard for 12mm glass.</p>		Satin Stainless	PGL90-SS	
			Polish	PGL90-PS	

POLARIS SOFT CLOSE HINGES

PRODUCT	DESCRIPTION
	<p>POLARIS Soft Close Hinges 155 Series</p> <p>The Polaris 155 Series RETROFIT HINGES were purposely designed to RETROFIT onto existing Spring Hinge gates. No need for costly new glass, quick and simple to install and available to suit almost every gate option. Featuring our “Quik-Adjust” Ratchet cap for simple speed adjustment and interchangeable dampers for complete customization closing force. Tested and NZ/AUS Pool compliance certified to 25,000 cycles.</p> <p>Retrofits directly into 8–12mm spring hinge glass gates (hole/cut out dependant)</p> <p>Both self closing and soft closing from any position</p> <p>Quick and easy to install / D.I.Y</p> <p>Quik-adjust ratchet cap for simple speed adjustment</p> 

PRODUCT	DESCRIPTION	FINISH	CODE	PRICE
	<p>POLARIS Soft Close Glass to Glass Hinge</p> <p>Retrofittable (various fixing options) Glass to Glass Soft Close gate hinge. 8–12mm Glass.</p> <p>45kg Max</p> <p><i>*SOLD AS A PAIR (2x Hinges)</i></p>	Satin Stainless	SC180-S	
		Polished Stainless	SC180-C	
		Black	SC180-BK	
	<p>POLARIS Soft Close Wall to Glass Hinge</p> <p>Retrofittable (various fixing options) Wall to Glass Soft Close gate hinge. 8–12mm Glass.</p> <p>45kg Max</p> <p><i>*SOLD AS A PAIR (2x Hinges)</i></p>	Satin Stainless	SC090-S	
		Polished Stainless	SC090-C	
		Black	SC090-BK	

EG GATE LATCHES

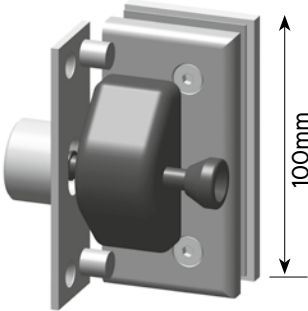
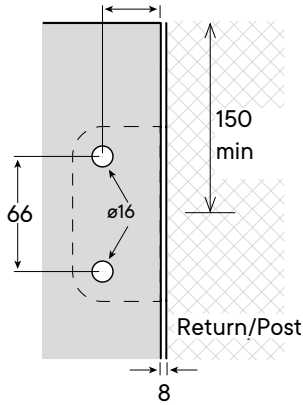
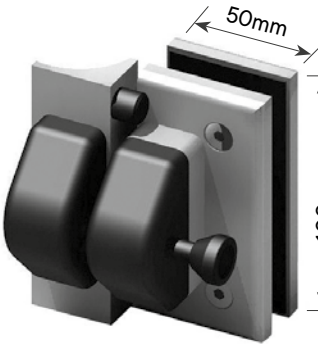
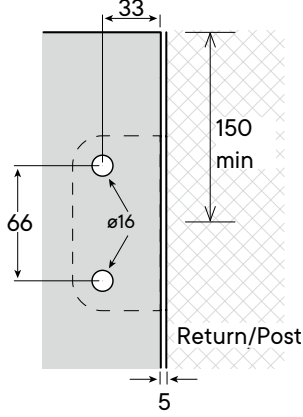
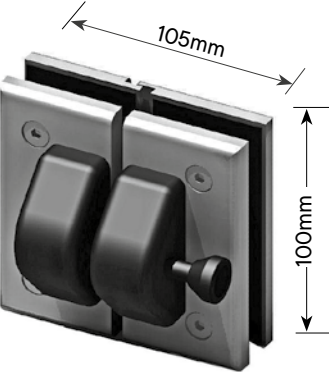
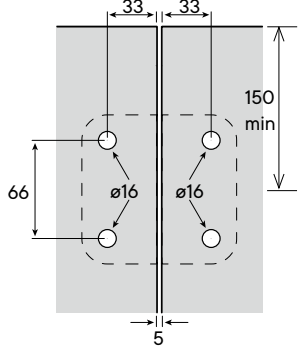
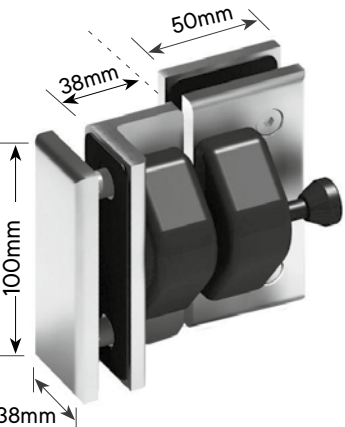
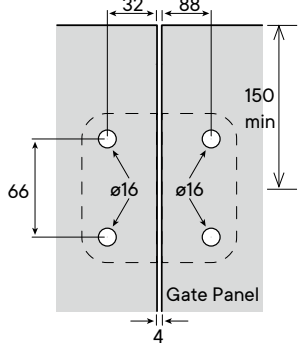





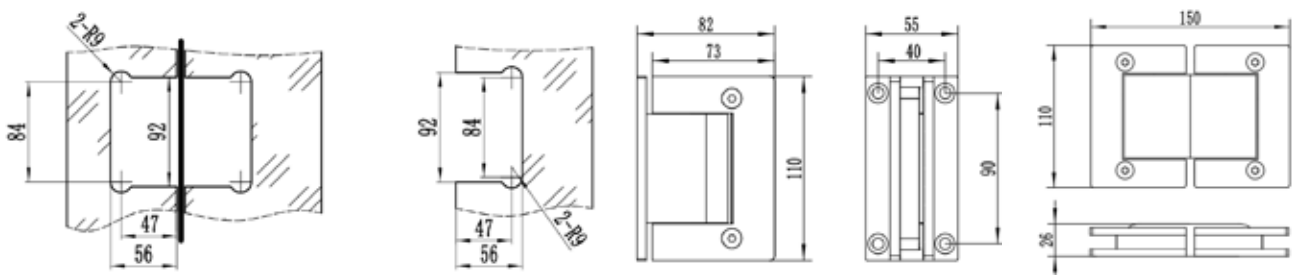

PRODUCT	DESCRIPTION	GLASS PREPARATION	FINISH	CODE	PRICE
	<p>EHPL1 Gate Latch and Strike</p> <p>Closes to a post or wall. Single action, self-latching magnetic operation.</p> <p>Standard for 12mm glass.</p>		Satin Stainless	EHPL1-SS	
	<p>EHPL1RP Round Post Gate Latch and Strike</p> <p>Gate 50mm dia. post mount. Single action, self-latching magnetic operation.</p> <p>Standard for 12mm glass.</p>		Satin Stainless	EHPL1RP-SS	
	<p>EHPL2 Gate Latch and Keeper</p> <p>Gate and side panel. Single action, self-latching magnetic operation.</p> <p>Standard for 12mm glass.</p>		Satin Stainless	EHPL2-SS	
	<p>EHPL290 Gate latch and keeper</p> <p>Gate that closes to a side panel at 90°. Single action, self-latching magnetic operation.</p> <p>Standard for 12mm glass.</p>		Satin Stainless	EHPL290-SS	

VIENNA HYDRAULIC GATE HINGES

PRODUCT	DESCRIPTION	TYPE	FINISH	CODE	PRICE (PR)
	<p>EH4T Glass to Wall Hydraulic Hinge</p> <p>Hinge opening angle 100°. Self-closing from any angle. Available in non-hold open and hold open options. Centre T Style backplate.</p> <p>Max recommended glass weight: 70kg Max recommended door span: 900mm Standard for 12mm glass, can be supplied for 10mm</p> <p><i>*SOLD AS A PAIR (2x Hinges)</i></p>	NON-HOLD OPEN	Satin Stainless	EH4NHOSS	
			Polished Stainless	EH4NHOPS	
		HOLD OPEN	Satin Stainless	EH4HOSS	
			Polished Stainless	EH4HOPS	
	<p>EH4L Glass to Wall Hydraulic Hinge</p> <p>Hinge opening angle 100°. Self-closing from any angle. Available in non-hold open and hold open options. Offset L Style backplate.</p> <p>Max recommended glass weight: 70kg Max recommended door span: 900mm Standard for 12mm glass, can be supplied for 10mm</p> <p><i>*SOLD AS A PAIR (2x Hinges)</i></p>	NON-HOLD OPEN	Satin Stainless	EH4NHOLSS	
			Polished Stainless	EH4NHOLPS	
		HOLD OPEN	Satin Stainless	EH4HOLSS	
			Polished Stainless	EH4HOLPS	
	<p>EH3 Glass to Glass Hydraulic Hinge</p> <p>Hinge opening angle 100°. Self-closing from any angle. Available in non-hold open and hold open options. Glass to Glass Style.</p> <p>Max recommended glass weight: 70kg Max recommended door span: 900mm Standard for 12mm glass, can be supplied for 10mm</p> <p><i>*SOLD AS A PAIR (2x Hinges)</i></p>	NON-HOLD OPEN	Satin Stainless	EH3NHOSS	
			Polished Stainless	EH3NHOPS	
		HOLD OPEN	Satin Stainless	EH3HOSS	
			Polished Stainless	EH3HOPS	

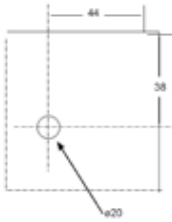

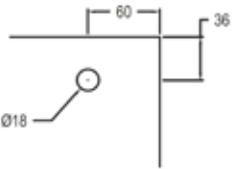
GATE PIVOT ARMS & PATCHES

PRODUCT	DESCRIPTION	TYPE	FINISH	CODE	PRICE
	PGA Patch to Patch Gate Pivot Arm Used with 2 MP20 Top Patch Fittings, Glass to Glass.		SSS	PGA-SS	
			PSS	PGA-PS	
	PWA Wall to Patch Gate Pivot Arm Suits Glass to MP20 Top Patch fitting 10-12mm glass,		SSS	PWA-SS	
			PSS	PWA-PS	
	PGH2 Glass to Patch Gate Pivot Arm Suits Glass to MP20 Top Patch fitting 10-12mm glass,		SSS	PGH2-SS	
			PSS	PGH2-PS	
	PGH6 Glass to Patch 90 Gate Pivot Arm Suits Glass to MP20 Top Patch fitting 10-12mm glass,		SSS	PGH6-SS	
	HPT20/MP20 Top Patch Fitting Suits 10-12mm glass, For Opus pivot range and fittings. Adjustable pivot insert, Factory set at 55mm		SSS	HPT20SS	
			PSS	HPT20PS	
			Black	HPT20BLK	

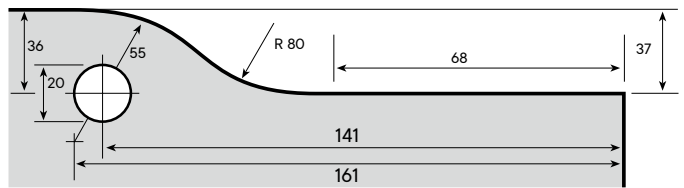
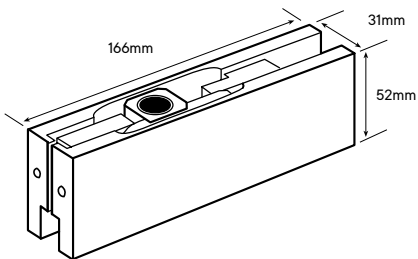

GATE PIVOTS, CLOSERS & FLOOR SPRINGS

PRODUCT	DESCRIPTION	TYPE	FINISH	CODE	PRICE
	HPT10 Bottom Patch Fitting Suits 10–12mm glass, For Opus floorspring range and HPT26 free swing pivot. Adjustable pivot insert, Factory set at 55mm		SSS	HPT10SS	
			PSS	HPT10PS	
			Black	HPT10BLK	

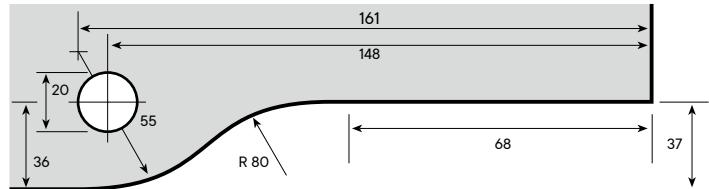
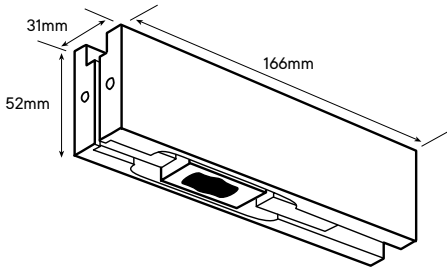

	EFS840 Hydraulic Floor Spring Patch Kit Double action floorspring including stainless steel cover plate. 2 spring strengths; 16Nm (weak), 25Nm (standard). Maximum door width 1100mm on standard spring and 800mm on weak spring. Maximum door weight 100kg. Non hold open version to be used only for Pool Gates. Suitable for use with Opus frameless patch fittings and rails. Warranty 5years or 500,000 cycles.	16Nm (weak)	SSS	EFS840NHOW	
		25Nm (standard)	SSS	EFS840NHO	

	FH100 EN3 Closer Hydraulic Bottom Patch Suits 8–12mm glass, Includes base pivot plate. Non hold open version only to be used for Pool Gates. Applicable for door width of 750mm to 1000mm and weight up to 100kg. 5 year Warranty.	SSS	EPCNHOSS	
		PSS	EPCNHOPS	
		Black	EPCNHOBK	

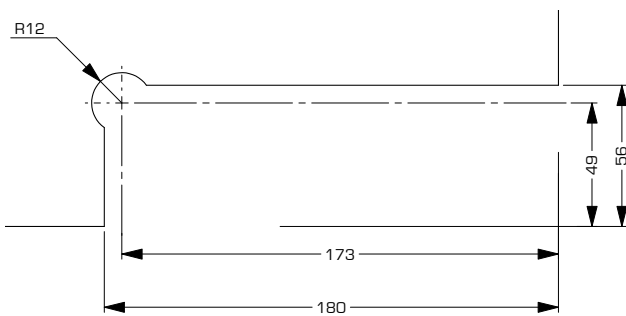



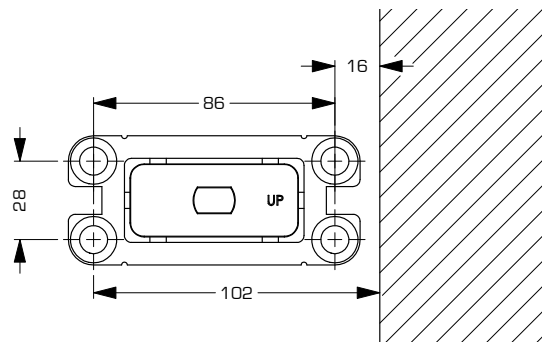





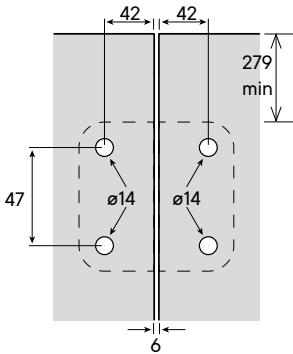

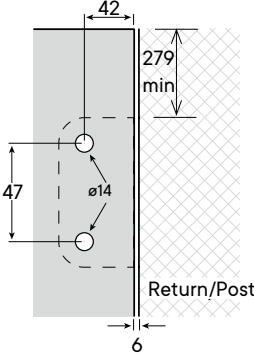
Glass detail

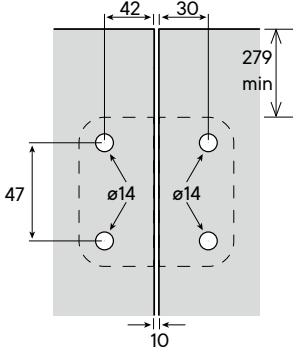

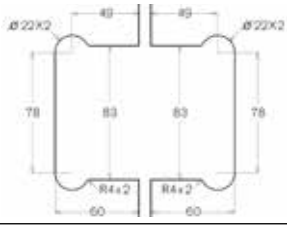
Base plate hole locations

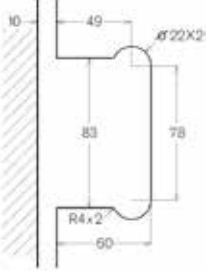
OZONE & LAGUNA GATE LATCHES & HINGES

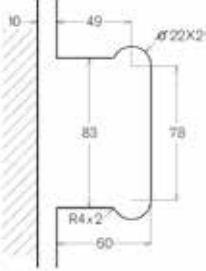





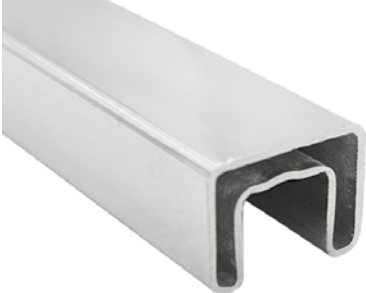
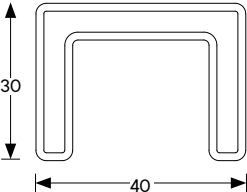
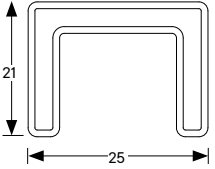

PRODUCT	DESCRIPTION	GLASS PREPARATION	FINISH	CODE	PRICE
	<p>OZONE PGH-7 Gate Latch and Keeper</p> <p>Gate and side panel. Single action, self-latching magnetic operation.</p> <p>Standard for 12mm glass.</p>		Satin Stainless	PGH7-SS	
	<p>OZONE PGH-11 Post Gate Latch and Strike</p> <p>Gate to post mount. Single action, self-latching magnetic operation.</p> <p>Standard for 12mm glass.</p>		Satin Stainless	PGH11-SS	
	<p>OZONE PGH-8 Gate latch and keeper</p> <p>Gate that closes to a side panel at 90°. Single action, self-latching magnetic operation.</p> <p>Standard for 12mm glass.</p>		Satin Stainless	PGH8-SS	
	<p>LAGUNA LH180 Pool Gate Hinge Glass to Glass</p> <p>Hydraulic hinges with adjustable closing speed. (Single)</p>		Satin Stainless	LH180-SS	
	<p>LAGUNA LH90T Pool Gate Hinge Glass to Wall</p> <p>Hydraulic hinges with adjustable closing speed. Center Backplate (Single)</p>		Satin Stainless	LH90T-SS	
	<p>LAGUNA LH90L Pool Gate Hinge Glass to Glass</p> <p>Hydraulic hinges with adjustable closing speed. Offset Backplate (Single)</p>		Satin Stainless	LH90L-SS	
			Polished Stainless	LH180-PS	
			Polished Stainless	LH90T-PS	
			Polished Stainless	LH90L-PS	

MALIBU GATE LATCHES & HINGES







PRODUCT	DESCRIPTION	GLASS PREPARATION	FINISH	CODE	PRICE
	<p>MALIBU MGL Gate Latch and Keeper</p> <p>Gate and side panel. Single action, self-latching magnetic operation.</p> <p>Standard for 12mm glass.</p>		Satin Stainless	MGL180-SS	●
			Polished Stainless	MGL180-PS	●
	<p>MALIBU MGL-P Post Gate Latch and Strike</p> <p>Gate to post mount. Single action, self-latching magnetic operation.</p> <p>Standard for 12mm glass.</p>		Satin Stainless	MGLP90-SS	●
			Polished Stainless	MGLP90-PS	●
	<p>MALIBU HH-180 Pool Gate Hinge Glass to Glass</p> <p>Pool gate hydraulic hinges with adjustable closing speed and adjustable closed position. NHO</p>		Satin Stainless		●
			Polished Stainless		●
	<p>MALIBU HH-90 Pool Gate Hinge Wall to Glass</p> <p>Pool gate hydraulic hinge Non Hold Open Centered back plate. 60mm.</p>		Satin Stainless		●
			Polished Stainless		●
	<p>MALIBU HH-90L Pool Gate Hinge Wall to Glass</p> <p>Pool gate hydraulic hinge Non Hold Open Offset back plate. 60mm.</p>		Satin Stainless		●
			Polished Stainless		●

BALUSTRADE & POOL
HANDRAIL SYSTEMS
& CLAMPS

S40/25 HANDRAIL FITTINGS

PRODUCT	DESCRIPTION	TYPE	CODE	PRICE	
  	S40 Squareline Interlinking Handrail Capping (5.8m) 5.8m stock lengths, 40mm wide x 30mm high, easy to install using simple tools, no on site welding required. Squareline is easily attached to the glass using a compression fit rubber molding. 2205 Duplex Suitable for 12–21.5mm glass Joiners, end caps and wall mount brackets are glued together using tube lock.	Satin Stainless	S40-SS		
		Polished Stainless	S40-PS		
	S25 Slimline Interlinking Handrail Capping (5.8m) 5.8m stock lengths, 25mm wide x 21mm high, easy to install using simple tools, no on site welding required. Squareline is easily attached to the glass using a compression fit rubber molding. 2205 Duplex Suitable for 10–12mm glass Joiners, end caps and wall mount brackets are glued together using tube lock.	Satin Stainless	S25-SS		
		Polished Stainless	S25-PS		
	Straight Joiner	40mm	S40J-180		
		25mm	S25J-180		
	End Cap	40mm	S40-EC		
		25mm	S25-EC		
	Wall Anchor	40mm	LH	S40-WAL	
			RH	S40-WAR	
		25mm	LH	S25-WAL	
			RH	S25-WAR	
	Cast 90deg Corner	40mm	S40-J90		
		25mm	S25-J90		
	Vertical Adjustable Joiner	40mm	S40-VAJ		
		25mm	S25-VAJ		
	Horizontal Adjustable Joiner	40mm	S40-HAJ		
		25mm	S25-HAJ		
	Link Rail Rubber Gasket		SR25 / 12–13.5mm		
			SR40 / 12–13.5mm		
			SR40 / 12–15mm		
			SR40 / 13–16mm		
			SR40 / 16–19mm		
	Link Rail Loctite 243 50mlbottle	243	TL2680		

GLASS CLAMPS

PRODUCT	DESCRIPTION	CODE	PRICE
	<p>Round Steel Glass Clamp - Flat Back</p> <p>No glass preparation required 35kg per clamp loading. 316 stainless steel (8mm, 10mm, 12mm)</p>	GCF-1	
	<p>Round Steel Glass Clamp - Round Back</p> <p>No glass preparation required Radius back to suit 50mm diameter post 35kg per clamp loading. 316 stainless steel (8mm, 10mm, 12mm)</p>	GCR-1	
	<p>Square Steel Glass Clamp - Flat Back</p> <p>No glass preparation required 35kg per clamp loading. 316 stainless steel (8mm, 10mm, 12mm)</p>	SS200	
	<p>Square Steel Glass Clamp - Round Back</p> <p>No glass preparation required Radius back to suit 50mm diameter post 35kg per clamp loading. 316 stainless steel (8mm, 10mm, 12mm)</p>	SS201	
	<p>Satin Stainless Steel Glass Clamp</p> <p>Adjustable to suit glass thickness. From 6mm to 10mm No Glass preparation required. 30kg per clamp loading. 316 Stainless steel</p>	SS101	
	<p>Security Pin</p> <p>Can be fitted into SS200 x SS201 clamps</p>	SP202	
	<p>Radius Back Plate</p> <p>To allow mounting of SS101 clamps to 50mm or 70mm diameter posts.</p>	RS102.50	
		RS102.70	

BALUSTRADE STIFFENER BRACKETS





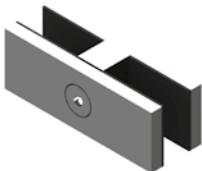
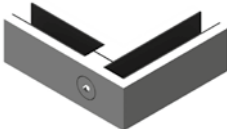
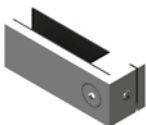

PRODUCT	DESCRIPTION	SIZE	CODE	PRICE
	H.D. Clamp 12 - 15mm Glass	90° glass to wall. 65mm x 55mm x 25mm.	SBW-15	
	Stiffener bracket - No holes required. Duplex 2205. Stainless Steel Satin finish.	90° glass to glass. 82mm x 55mm x 25mm.	SB90-15	
		180° glass to glass. 103mm overall x 25mm.	SB180-15	
	H.D. Clamp 17.5 - 21.5mm Glass	90° glass to wall. 65mm x 55mm x 25mm.	SBW-21	
	Stiffener bracket - No holes required. Duplex 2205. Stainless Steel Satin finish.	90° glass to glass. 88mm x 55mm x 25mm.	SB90-21	
		180° glass to glass. 103mm overall x 25mm.	SB180-21	

All brackets are supplied with a selection of gaskets to suit glass thickness and includes stainless steel clamping plates.

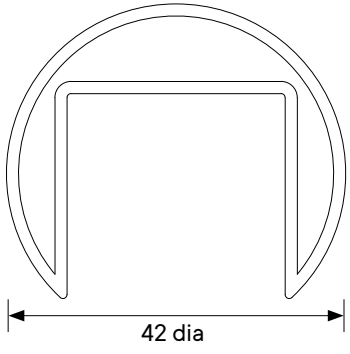
PANEL CLAMPS

PRODUCT	DESCRIPTION	FINISH	CODE	PRICE
	Balustrade Panel Clamp 180° Will help align & stiffen 12-13.5mm Balustrade Panels No holes required 316SSS	Polish	BC25-180-PS	
		Satin	BC25-180-SS	
		Black	BC25-180-BK	
	Balustrade Panel Clamp 90° Will help align & stiffen 12-13.5mm Balustrade Panels External screws. No holes required 316SSS	Polish	BC25-90-PS	
		Satin	BC25-90-SS	
		Black	BC25-90-BK	
	Balustrade Panel Clamp Wall Mount Will help align & stiffen 12-13.5mm Balustrade Panels External screws. No holes required 316SSS	Polish	BC25-WM-PS	
		Satin	BC25-WM-SS	
		Black	BC25-WM-BK	



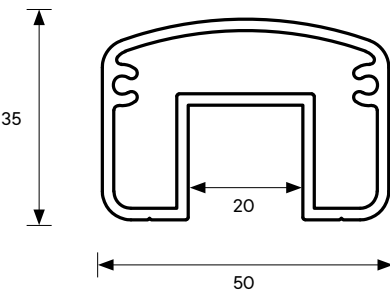
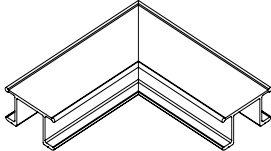
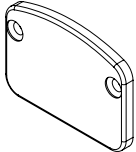
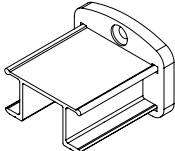
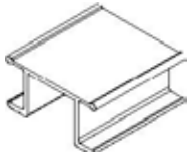

HRC1 HANDRAIL FITTINGS

PRODUCT	DESCRIPTION	FINISH	CODE	PRICE
	<p>HRC1 Roundline Interlinking Handrail (2205 Duplex) Capping</p> <p>5.8m stock lengths and Easy to install using simple tools, no on site welding required and easily attached to the glass using a compression fit rubber molding.</p> <p>Suitable for 12mm, 15mm and 19mm toughened safety glass and 13.5mm and 17.5mm toughened laminated safety glass</p> <p>Joiners, end caps and wall mount brackets are glued together using tube lock.</p>	Satin Stainless	HRC1-SS	
		Polished Stainless	HRC1-PS	
	<p>Straight Joiner</p>		HRC1SJ	
	<p>End Cap</p>		HRC1EC	
	<p>Wall Anchor</p>		HRC1WA	
	<p>Cast 90deg Corner</p>		HRC1C90	
	<p>Vertical Adjustable Joiner</p>		HRC1VAJ	
	<p>Horizontal Adjustable Joiner</p>		HRC1HAJ	

HRC3 HANDRAIL





PRODUCT	DESCRIPTION	FINISH	CODE	PRICE
	<p>HRC3 Archline Aluminium Interlinking Handrail Capping</p> <p>5m stock lengths and Easy to install using simple tools, no on site welding required</p> <p>Suitable for 12mm and 15mm toughened safety glass and 13.5mm and 17.5mm toughened laminated safety glass.</p>	Powdercoat Silver Pearl	HRC3-SP	
		Mill Finish	HRC3-M	
	Corner 90° Joiner		HRC3J90	
	End Cap		HRC3EC	
	Wall Mount Bracket		HRC3WM	
	Straight Joiner		HRC3SJ	
PRODUCT	SIZE	CODE	PRICE	
Glazing Tape	3mm (12mm Glass)	HRC3T12		
	6m Roll	1.6mm (15mm Glass)	HRC3T15	
Foam Backing Rod	6mm	HRC38R		

HANDRAIL BRACKETS

PRODUCT	DESCRIPTION	DIMENSIONS	TYPE	CODE	PRICE
	<p>Round Arm Section Bracket</p> <p>Round Section Arm. Suitable for Timber or Stainless Steel Handrails.</p> <p>316 Satin Stainless Steel (SS)</p> <p>10-15mm Glass (*Specify Glass thickness on order)</p>		10-15mm Glass	HBR90G	
			Solid Wall Fixing	HBR90W	
	<p>Square Arm Section Bracket</p> <p>Square Section Arm. Suitable for Timber or Stainless Steel Handrails.</p> <p>316 Satin Stainless Steel (SS)</p> <p>10-15mm Glass (*Specify Glass thickness on order)</p>		10-15mm Glass	HBS90G	
			Solid Wall Fixing	HBS90W	
	<p>Heavy Duty – Round Arm Section Bracket</p> <p>Round Section Arm. Suitable for Stainless Steel Handrails.</p> <p>Requires a welded connection to the rail.</p> <p>316 Satin Stainless Steel (SS)</p> <p>10-15mm Glass (*Specify Glass thickness on order)</p>		10-15mm Glass	HBHDR90G	
	<p>Square Cover Kit</p>		Satin Stainless	HB50SCK	

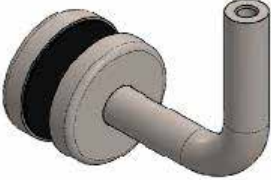
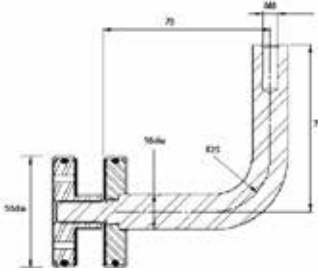
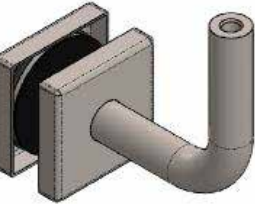
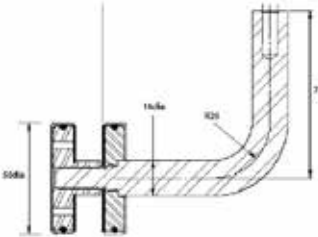
Additional HR50/R90 and S90 MFG brackets available on request P.OA.

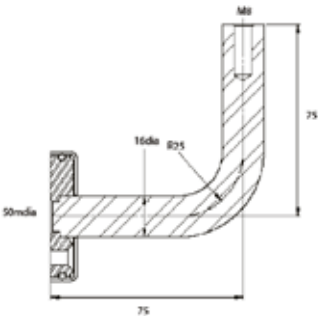
HANDRAIL BRACKETS

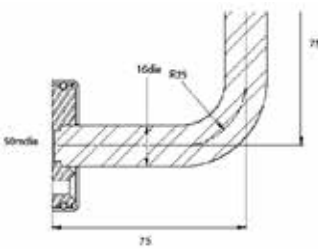
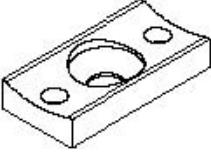
PRODUCT	DESCRIPTION	DIMENSIONS	FINISH	CODE	PRICE
	HBGM1 Round Glass Mounted Handrail Bracket 2205 Duplex stainless steel, used with balustrades that require a load supporting interlinking rail 26mmØ hole in glass		Satin Stainless	HBGM1-SS	
			Polished Stainless	HBGM1-PS	
	HBGM2 Square Glass Mounted Handrail Bracket Made from 2205 Duplex stainless steel, used with balustrades that require a load supporting interlinking rail 26mmØ hole in glass		Satin Stainless	HBGM2-SS	
			Polished Stainless	HBGM2-PS	
	HBWM1 Round Wall Mounted Handrail Bracket Made from 2205 Duplex stainless steel. Mounted to the wall using 3x countersunk screws (screws not included)		Satin Stainless	HBWM1-SS	
			Polished Stainless	HBWM1-PS	
	HBWM2 Square Wall Mounted Handrail Bracket Made from 2205 Duplex stainless steel. Mounted to the wall using 3x countersunk screws (screws not included)		Satin Stainless	HBWM2-SS	
			Polished Stainless	HBWM2-PS	
	HBFS Handrail Bracket Fixing Straddle 2205 Duplex stainless steel. For mounting handrail sections to the handrail bracket. Supplied with M8 screw for fixing to the handrail bracket.		Satin Stainless	HBFS-SS	
			Polished Stainless	HBFS-PS	



OPUS HARDWARE SERVICE OVERVIEW

FREIGHT SERVICE & PRICING

SERVICE	COURIER BAG		SMALL BOX		LARGE BOX/LENGTH		>1.8-2.4M+ LENGTH		>2.4M+ LENGTH	
	NATIONWIDE		NORTH	SOUTH	NORTH	SOUTH	NORTH	SOUTH	NORTH	SOUTH
OVERNIGHT							N.A	N.A	N.A	N.A
2-3 Day Courier	N.A	N.A							N.A	N.A
2-5 Day Truck	N.A	N.A	N.A	N.A	N.A	N.A	N.A	N.A		

CARRIERS       **aramex aramex**  

1-3 Day AKL Freight

FREIGHT FREE ON ALL ORDERS OVER \$1500+GST (excludes large & long balustrade/extrusion orders)
 *Pricing subject to change
 *Pricing & Lead Times indicative only. Please get in touch with customer services for an POA Freight Quote if needed.
 *Opus cannot guarantee the delivery turnaround service due to unpredictable possibilities and delays that can affect carriers lead times.
 *Oversized Deliveries & Shipments such as Balustrades POA.



OPUS HARDWARE | SERVICE OFFERING

SERVICE	NORTH	SOUTH	DELIVERY
Standard Stock Items	1 - 3	2 - 4	Working days (Standard Delivery) from order placement.
Oversized Items	2 - 4	4 - 6	Working days (Standard Delivery) from order. (Greater than 2.5m in length, or overweight)
Powdercoated Items	7 - 10	10 - 15	Working days (Standard Delivery) from order placement.
Anodised Items	20 - 25	25 - 30	Working days (Standard Delivery) from order placement.
Site Specific PS1's	10 - 15		Working days (Standard Duration) from order placement.
Custom or Specific Engineering		TBC	At time of order placement with Customer Service Department.
International Orders			

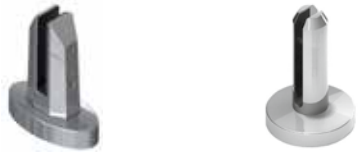

*Opus cannot guarantee the delivery turnaround service due to unpredictable possibilities and delays that can affect carriers lead times. Lead Times indicative only.

POWDERCOATING PRICELIST

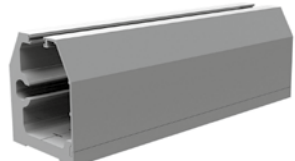
DESCRIPTION	CODE & PRODUCT	PRICE	PRODUCT
Standoffs, Disc Sets PER DISC	PC1-DISC		
Spigots, Mini Posts PER POST	PC1-SPIGOT		
Gate Hinges, Latches PER HINGE, LATCH	PC-HINGE		
Brackets, Clamps PER BRACKET	PC-BRACKET		
Covers, Channels, Extrusions & Handrails PER M OF EXTRUSION	PC-PERM		

*Pricing subject to change

*Minimum spend \$150+GST per order

*Pricing based on standard Powdercoat Range, special powders may incur surcharge

*Project rates or larger qty jobs P.O.A.

NOTES

NOTES



0800 404 043
opushardware.com

